

SIEMENS

SITRANS T

Temperature sensors SITRANS TS100/TS200/TS300/ TS500/TSinsert/TSthermowell

Compact Operating Instructions

<u>Introduction</u>	1
<u>Safety instructions</u>	2
<u>Installing/mounting</u>	3
<u>Connecting</u>	4
<u>Commissioning</u>	5
<u>Service and maintenance</u>	6
<u>Technical data</u>	7
<u>Product documentation and support</u>	A

Legal information

Warning notice system

This manual contains notices you have to observe in order to ensure your personal safety, as well as to prevent damage to property. The notices referring to your personal safety are highlighted in the manual by a safety alert symbol, notices referring only to property damage have no safety alert symbol. These notices shown below are graded according to the degree of danger.

 DANGER
indicates that death or severe personal injury will result if proper precautions are not taken.

 WARNING
indicates that death or severe personal injury may result if proper precautions are not taken.

 CAUTION
indicates that minor personal injury can result if proper precautions are not taken.

NOTICE
indicates that property damage can result if proper precautions are not taken.

If more than one degree of danger is present, the warning notice representing the highest degree of danger will be used. A notice warning of injury to persons with a safety alert symbol may also include a warning relating to property damage.

Qualified Personnel

The product/system described in this documentation may be operated only by **personnel qualified** for the specific task in accordance with the relevant documentation, in particular its warning notices and safety instructions. Qualified personnel are those who, based on their training and experience, are capable of identifying risks and avoiding potential hazards when working with these products/systems.

Proper use of Siemens products

Note the following:

 WARNING
Siemens products may only be used for the applications described in the catalog and in the relevant technical documentation. If products and components from other manufacturers are used, these must be recommended or approved by Siemens. Proper transport, storage, installation, assembly, commissioning, operation and maintenance are required to ensure that the products operate safely and without any problems. The permissible ambient conditions must be complied with. The information in the relevant documentation must be observed.

Trademarks

All names identified by ® are registered trademarks of Siemens AG. The remaining trademarks in this publication may be trademarks whose use by third parties for their own purposes could violate the rights of the owner.

Disclaimer of Liability

We have reviewed the contents of this publication to ensure consistency with the hardware and software described. Since variance cannot be precluded entirely, we cannot guarantee full consistency. However, the information in this publication is reviewed regularly and any necessary corrections are included in subsequent editions.

Table of contents

1	Introduction	5
1.1	Purpose of this documentation	5
1.2	Scope of documentation	5
1.3	Document history	5
1.4	Intended use	5
1.5	Checking the consignment	6
1.6	Security information	6
1.7	Transportation and storage	7
1.8	Notes on warranty	7
2	Safety instructions	9
2.1	Preconditions for use	9
2.1.1	Laws and directives	9
2.1.2	Conformity with European directives	10
2.1.3	Improper device modifications	10
2.2	Requirements for special applications	10
2.3	Use in hazardous areas	11
2.4	Use in flameproof enclosures "d" and protection in enclosures "tb"	11
2.4.1	For SITRANS TS500	12
2.4.1.1	Installation in "Flameproof enclosures "d" and enclosures "tb"	12
2.4.2	For SITRANS TSinsert/TS100/TS200/TS500	13
3	Installing/mounting	15
3.1	Basic safety notes	15
3.1.1	Installation and location requirements	16
3.1.2	Proper mounting	17
3.2	Mounting the SITRANS TS500	19
3.3	Mounting SITRANS TS300 in clamp-on design	20
3.4	Disassembly	21
4	Connecting	23
4.1	Basic safety notes	23
4.1.1	For SITRANS TSinsert	26
4.1.2	For SITRANS TSinsert/TS100/TS200/TS500	26
4.1.3	For SITRANS TS100/TS200	26
4.1.4	For SITRANS TS500	27
4.2	Connecting the device	27
4.3	Connecting the resistance thermometer	27

4.4	Connecting the thermocouple.....	28
4.5	Connecting the plug-in connector	29
5	Commissioning	31
5.1	Basic safety notes.....	31
5.2	Commissioning	32
6	Service and maintenance	33
6.1	Basic safety notes.....	33
6.1.1	Maintenance.....	33
6.1.2	SITRANS TS500	33
6.2	Cleaning	34
6.3	Maintenance and repair work.....	35
6.3.1	SITRANS TS500	36
6.3.2	Service and maintenance	36
6.4	Return procedure	37
6.5	Disposal.....	38
7	Technical data	39
7.1	Rated conditions	39
7.1.1	Minimum permissible ambient temperatures in the connection area of the sensor	39
7.1.2	Maximum permissible ambient temperatures in the connection area of the sensor	40
7.1.2.1	General limitations for compression fittings	40
7.1.2.2	SITRANS TS100	40
7.1.2.3	SITRANS TS500	41
7.1.3	Maximum permitted sample temperatures within the process	50
7.1.4	Measuring range.....	51
7.2	Construction.....	52
7.3	Electrical data	53
7.4	Certificates and approvals.....	53
7.4.1	SITRANS TSInsert/TS100/TS200/TS500	54
7.4.2	SITRANS TS500	54
A	Product documentation and support	57
A.1	Product documentation	57
A.2	Technical support.....	58
A.3	QR code label.....	58
	Index	59

Introduction

1.1 Purpose of this documentation

These instructions are a brief summary of important features, functions and safety information, and contain all information required for safe use of the device. Read the instructions carefully prior to installation and commissioning. In order to use the device correctly, first review its principle of operation.

The instructions are aimed at persons who install and commission the device.

To realize optimum performance from the device, read the complete operating instructions.

1.2 Scope of documentation

"7MC../7MT.." stands for:

Article no.	Product
7MC71..	SITRANS TS100
7MC72..	SITRANS TS200
7MC80..	SITRANS TS300
7MC75..	SITRANS TS500 (Europe portfolio)
7MC65..	SITRANS TS500 (North America portfolio)
7MC55..	SITRANS TS500 (Asia portfolio)
7MC.01..	TSinsert
7MT..	TSthermowell

1.3 Document history

The overview below summarizes the most important changes in the documentation when compared to the previous edition.

Edition	Comment
08/2020	SITRANS TH320 and TH420 with display (7MF7902-1D) added
01/2018	TSthermowell added

1.4 Intended use

The temperature sensors of the SITRANS TS product family are used for measuring temperatures in industrial plants.

Depending on the specifications, sensors can be combined with different connection heads, extension tubes, and process connections. This makes the sensors suitable for a variety of process engineering applications, in the following sectors:

- Petrochemical industry
- Pharmaceuticals industry
- Biotechnology
- Food production

See also

Technical data (Page 39)

1.5 Checking the consignment

1. Check the packaging and the delivered items for visible damages.
2. Report any claims for damages immediately to the shipping company.
3. Retain damaged parts for clarification.
4. Check the scope of delivery by comparing your order to the shipping documents for correctness and completeness.

 WARNING
Using a damaged or incomplete device
Risk of explosion in hazardous areas.
<ul style="list-style-type: none">• Do not use damaged or incomplete devices.

1.6 Security information

Siemens provides products and solutions with industrial security functions that support the secure operation of plants, systems, machines, and networks.

In order to protect plants, systems, machines and networks against cyber threats, it is necessary to implement – and continuously maintain – a holistic, state-of-the-art industrial security concept. Siemens' products and solutions form one element of such a concept.

Customers are responsible for preventing unauthorized access to their plants, systems, machines and networks. These systems, machines and components should only be connected to the enterprise network or the Internet if and only to the extent necessary and with appropriate security measures (firewalls and/or network segmentation) in place.

You can find more information on protective measures in the area of industrial security by visiting:
<https://www.siemens.com/industrialsecurity>.

Siemens' products and solutions undergo continuous development to make them more secure. Siemens strongly recommends performing product updates as soon as they are available and

using only the latest product versions. Use of product versions that are no longer supported, and failure to apply latest updates may increase customer's exposure to cyber threats.

To stay informed about product updates, subscribe to the Siemens Industrial Security RSS Feed under <https://www.siemens.com/industrialsecurity>.

1.7 Transportation and storage

To guarantee sufficient protection during transport and storage, observe the following:

- Keep the original packaging for subsequent transportation.
- Devices/replacement parts should be returned in their original packaging.
- If the original packaging is no longer available, ensure that all shipments are properly packaged to provide sufficient protection during transport. Siemens cannot assume liability for any costs associated with transportation damages.

NOTICE
Insufficient protection during storage
The packaging only provides limited protection against moisture and infiltration.
<ul style="list-style-type: none">• Provide additional packaging as necessary.

Special conditions for storage and transportation of the device are listed in Technical data (Page 39).

1.8 Notes on warranty

The contents of this manual shall not become part of or modify any prior or existing agreement, commitment or legal relationship. The sales contract contains all obligations on the part of Siemens as well as the complete and solely applicable warranty conditions. Any statements regarding device versions described in the manual do not create new warranties or modify the existing warranty.

The content reflects the technical status at the time of publishing. Siemens reserves the right to make technical changes in the course of further development.

Safety instructions

2.1 Preconditions for use

This device left the factory in good working condition. In order to maintain this status and to ensure safe operation of the device, observe these instructions and all the specifications relevant to safety.

Observe the information and symbols on the device. Do not remove any information or symbols from the device. Always keep the information and symbols in a completely legible state.

Symbol	Explanation
	Consult operating instructions

2.1.1 Laws and directives

Observe the safety rules, provisions and laws applicable in your country during connection, assembly and operation. These include, for example:

- National Electrical Code (NEC - NFPA 70) (USA)
- Canadian Electrical Code (CEC) (Canada)

Further provisions for hazardous area applications are for example:

- IEC 60079-14 (international)
- EN 60079-14 (EU)

SITRANS TSthermowell

The thermowell is affected by the static, dynamic and chemical load from the process parameters including static and dynamic load, flow induced vortexes. This has influence on the shape of the thermometer, stem diameter and insertion length.

Observe the test certification, provisions and laws applicable in your country during connection, assembly and operation. These include:

- ASME PTC 19.3
- DIN 43772 Annex 1-2
- AD-directive
- VDI/VDE 3511-5

In critical applications, a thermowell stress calculation is recommended:

- ASME PTC 19.3-TW2016
- Dittrich/Klotter-method engineering service

2.1.2 Conformity with European directives

The CE marking on the device symbolizes the conformity with the following European directives:

Electromagnetic compatibility EMC 2014/30/EU	Directive of the European Parliament and of the Council on the approximation of the laws of the Member States relating to electromagnetic compatibility and repealing Directive 89/336/EEC.
Atmosphère explosible ATEX 2014/34/EU	Directive of the European Parliament and the Council on the approximation of the laws of the Member States concerning equipment and protective systems intended for use in potentially explosive atmospheres.

The applicable directives can be found in the EC conformity declaration of the specific device.

See also

Product documentation (Page 57)

2.1.3 Improper device modifications

 WARNING
Improper device modifications Risk to personnel, system and environment can result from modifications to the device, particularly in hazardous areas. <ul style="list-style-type: none">• Only carry out modifications that are described in the instructions for the device. Failure to observe this requirement cancels the manufacturer's warranty and the product approvals.

2.2 Requirements for special applications

Due to the large number of possible applications, each detail of the described device versions for each possible scenario during commissioning, operation, maintenance or operation in systems cannot be considered in the instructions. If you need additional information not covered by these instructions, contact your local Siemens office or company representative.

Note

Operation under special ambient conditions

We highly recommend that you contact your Siemens representative or our application department before you operate the device under special ambient conditions as can be encountered in nuclear power plants or when the device is used for research and development purposes.

2.3 Use in hazardous areas

Qualified personnel for hazardous area applications

Persons who install, connect, commission, operate, and service the device in a hazardous area must have the following specific qualifications:

- They are authorized, trained or instructed in operating and maintaining devices and systems according to the safety regulations for electrical circuits, high pressures, aggressive, and hazardous media.
- They are authorized, trained, or instructed in carrying out work on electrical circuits for hazardous systems.
- They are trained or instructed in maintenance and use of appropriate safety equipment according to the pertinent safety regulations.

 WARNING
<p>Use in hazardous area</p> <p>Risk of explosion.</p> <ul style="list-style-type: none"> • Only use equipment that is approved for use in the intended hazardous area and labeled accordingly. • Do not use devices that have been operated outside the conditions specified for hazardous areas. If you have used the device outside the conditions for hazardous areas, make all Ex markings unrecognizable on the nameplate.

 WARNING
<p>Loss of safety of device with type of protection "Intrinsic safety Ex i"</p> <p>If the device or its components have already been operated in non-intrinsically safe circuits or the electrical specifications have not been observed, the safety of the device is no longer ensured for use in hazardous areas. There is a risk of explosion.</p> <ul style="list-style-type: none"> • Connect the device with type of protection "Intrinsic safety" solely to an intrinsically safe circuit. • Observe the specifications for the electrical data on the certificate and/or in Technical data (Page 39).

2.4 Use in flameproof enclosures "d" and protection in enclosures "tb"

 WARNING
<p>Impermissible repair of explosion protected devices</p> <p>Risk of explosion in hazardous areas</p> <ul style="list-style-type: none"> • Repair must be carried out by Siemens authorized personnel only.

 WARNING
Electrostatic charge
Risk of explosion in hazardous areas if electrostatic charges develop, for example, when cleaning plastic surfaces with a dry cloth.
<ul style="list-style-type: none">• Prevent electrostatic charging in hazardous areas.

2.4.1 For SITRANS TS500

2.4.1.1 Installation in "Flameproof enclosures "d" and enclosures "tb"

- The enclosure types AG0, AH0, AU0, AV0 and SITRANS TF for temperature sensors of the TS500 series must be connected using suitable cable entry fixtures or conduit systems that meet the requirements of IEC/EN 60079-1, sections 13.1 and 13.2 (with separate test certificate).
- Cable entry fixtures (thread conduits) and sealing plugs in the basic design must not be used in the sender and receiver enclosures.
- All openings not in use on the sender and receiver enclosures must be sealed as specified in IEC/EN 60079-1, section 11.9.
- The connecting cable of the enclosure types AG0, AH0, AU0, AV0 and SITRANS TF for the temperature sensor of the TS500 series must be installed so that permanent wiring and adequate protection against damages is ensured.
- If the temperature at the entry fixtures were to exceed 60 °C, the connecting cables must be heat resistant.
- When the connection is made in a potentially hazardous area, the connecting cable (free cable end) of the enclosure types AG0, AH0, AU0, AV0 and TF for the temperature sensors of the TS500 series must be installed in an enclosure that meets the requirements of an approved degree of protection as specified in IEC/EN 60079-0, section 1.
- All types must be installed in sensor pockets with an adequate degree of protection for the respective application.
- When a SITRANS TS500 with XP degree of protection is combined with a sensor pocket, ASME PTC19.3 must be observed and a minimum wall thickness of 1 mm should be considered.
- To separate Zone 1 from Zone 2 in a hazardous area, a wall thickness of ≥ 1 mm with austenitic stainless steel should be considered. Also take into account the existing process conditions.
When a sensor pocket is installed correctly and is sealed tight in Zone 0, the sensor screwed into this sensor pocket must be approved for at least Zone 1.
- Any adequately dimensioned sensor pockets must be fully seated in the thread after five full rotations and be ready to use.
- Any comments to this effect must be delivered with the device in an appropriate form.

2.4 Use in flameproof enclosures "d" and protection in enclosures "tb"

- A technical standard is in effect for mounted or installed components (terminal compartments, sockets, cable entry fixtures, plug-in connectors) that meets at least the specifications in the certificate of conformity; a separate test certificate must also have been issued for these components.
- Use the device to measure temperatures in accordance with the technical specifications for the maximum ambient temperatures in the connection area of the sensor. See sections Gas hazardous area: Ex d / XP (Page 47) and Dust hazardous area: Ex i / IS / Ex tb / DIP (Page 49).

2.4.2 For SITRANS TSinsert/TS100/TS200/TS500

NOTICE
Ambient temperature too high
Damage to cable sheath.
<ul style="list-style-type: none">• At an ambient temperature ≥ 60 °C (140 °F), use heat-resistant cables suitable for an ambient temperature at least 20 °C (36 °F) higher.

2.4 Use in flameproof enclosures "d" and protection in enclosures "tb"

Installing/mounting

3.1 Basic safety notes

 WARNING**Exceeded maximum permissible operating pressure**

Risk of injury or poisoning.

The maximum permissible operating pressure depends on the device version, pressure limit and temperature rating. The device can be damaged if the operating pressure is exceeded. Hot, toxic and corrosive process media could be released.

Ensure that maximum permissible operating pressure of the device is not exceeded. Refer to the information on the nameplate and/or in Technical data (Page 39).

 WARNING**Unsuitable connecting parts**

Risk of injury or poisoning.

In case of improper mounting, hot, toxic, and corrosive process media could be released at the connections.

- Ensure that connecting parts (such as flange gaskets and bolts) are suitable for connection and process media.

 CAUTION**Seal between extension and conduit**

- The seal between the device extension and the conduit must only be used once.

 WARNING**Incorrect mounting at Zone 0**

Risk of explosion in hazardous areas.

- Ensure sufficient tightness at the process connection.
- Observe the standard IEC/EN 60079-14.

 CAUTION
Hot surfaces resulting from hot process media
Risk of burns resulting from surface temperatures above 65 °C (149 °F).
<ul style="list-style-type: none">• Take appropriate protective measures, for example contact protection.• Make sure that protective measures do not cause the maximum permissible ambient temperature to be exceeded. Refer to the information in Technical data (Page 39).

 CAUTION
External stresses and loads
Damage to device by severe external stresses and loads (e.g. thermal expansion or pipe tension). Process media can be released.
<ul style="list-style-type: none">• Prevent severe external stresses and loads from acting on the device.

Note

In order to meet the flame-retardant requirements of the attached cable, only use type-tested sheathed cables with a cable connection length of ≥ 6 m for a cable length.

3.1.1 Installation and location requirements

 CAUTION
High vibration area
Especially with the stainless steel housing version of TS500, use short extensions or external supports when used in a high vibration area.
When TS100/200 sensors are installed in a high vibrating area, use also external supports to fix the probe stem: the unsupported length must not exceed 150 mm and the free end must not exceed 100 mm.

NOTICE
Direct sunlight
Damage to device.
The device can overheat or materials become brittle due to UV exposure.
<ul style="list-style-type: none">• Protect the device from direct sunlight.• Make sure that the maximum permissible ambient temperature is not exceeded. Refer to the information in Technical data (Page 39).

 CAUTION
Process load The thermowell is affected by the static, dynamic and chemical load from the process parameters, e.g. static and dynamic load, flow induced vortexes. This has influence to the shape of the thermometer, stem diameter and insertion length. Ensure that the applicable and relevant directives and standards are respected, e.g. ASME PTC 19.3, DIN43772 Annex 1-2, AD-directive, VDI/VDE 3511-5. In critical applications, a thermowell stress calculation according ASME PTC 19.3-TW2016 or Dittrich/Klotter-method is recommended as an engineering service.

3.1.2 Proper mounting

 DANGER
Protective tube ruptures Protective tubes that are not suitable for the process or application in question can rupture and result in serious damage to property and personal injuries. <ul style="list-style-type: none">• Make sure that the protective tube is suitable for the respective mounting method and application. If necessary, check the selection and order data of your protective tube.

 WARNING
Electrostatic charge Danger of explosion in hazardous areas if electrostatic charges develop, for example, in strong airflows in close proximity to belt conveyors. <ul style="list-style-type: none">• Avoid electrostatic charge at the plastic head type BMO when defining the installation site.

Note

Penetration of water into the plastic head type BMO

Device failure.

- To reach IP54 with a plastic head type BMO, make sure that the mounting angle is in the range of -14 to 194° (208°, see image below).

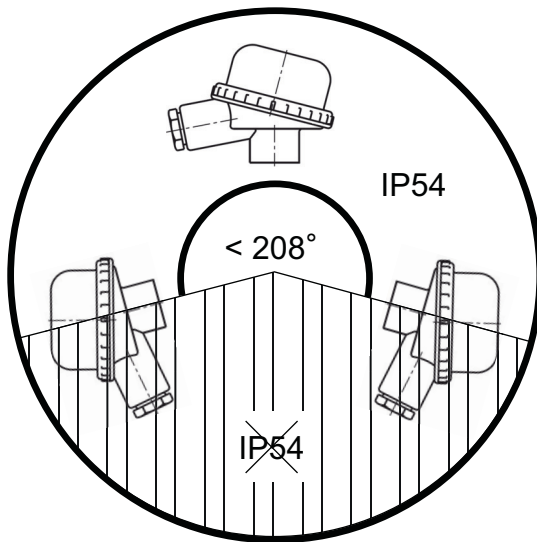

Figure 3-1 Mounting angle of plastic head type BM0

⚠ CAUTION

Loss of IP protection

Do not unscrew the device housing from the mounted parts with NPT threaded connection.

NOTICE

Incorrect mounting

The device can be damaged, destroyed, or its functionality impaired through improper mounting.

- Before installing, ensure there is no visible damage to the device.
- Make sure that process connectors are clean, and suitable gaskets and glands are used.
- Mount the device using suitable tools. Refer to the information in Technical data (Page 39) for installation torque requirements.
- Avoid temperature or mechanical shocks during mounting.
- Avoid excessive force or damaging of the on-site mechanical connections.
- Do not deform or adapt the thermowells.
- The use of additive seal or sealant (not in scope of delivery) is recommended between sensor and thermowell.
- Thermowells from carbon steel are protected against corrosion. Clean the thermowell before mounting to avoid poisoning of the sensor and mounting problems.

Note

Loss of degree of protection

Damage to device if the enclosure is open or not properly closed. The degree of protection specified on the nameplate is no longer guaranteed.

3.2 Mounting the SITRANS TS500

Requirement

The device is suitable for the process with regard to the process connection, media compatibility, temperature resistance and measuring range. See section Technical data (Page 39).

Procedure

1. You prevent faults caused by the heat dissipation in non-representative arrangements by observing the following basic rules:
2. Select an optimal immersion depth. Estimate the immersion depth using the formulas listed in Estimation of immersion depth (Page 52).
If permitted by the flow velocity, a sensor arrangement between one-third and one-half of the conduit diameter is recommended.
3. If the process load at the sensor pocket permits the exposition, select a measurement location with greater flow velocity.
4. Ensure that there is sufficient thermal insulation of the external components of the thermometer.
5. Ensure that external parts have small surfaces.
6. Select the optimum mounting position for the process in question.

3.3 Mounting SITRANS TS300 in clamp-on design

7. With small conduit diameters, mount the sensors against the direction of flow. Angled ② or in a pipe elbow ③.

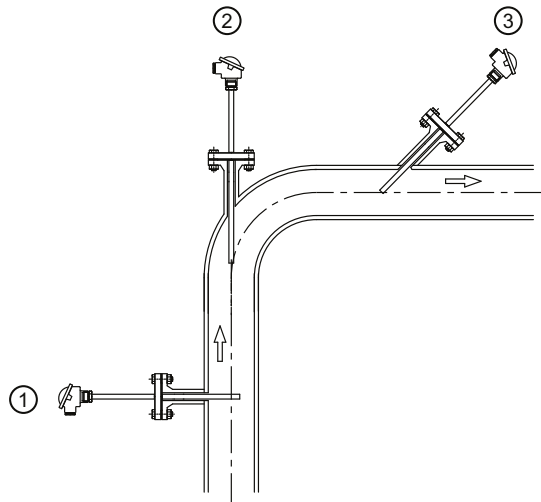

- ① At a right angle to the flow
- ② In the pipe elbow against the direction of flow
- ③ Angled against the direction of flow

Figure 3-2 Possible mounting positions of the sensor

8. Observe the torques required between device extension and conduit Torques between device extension and conduit (Page 52).
- If customized adaptations are necessary (only M24 connectors), note the required torques between the device head and extension as specified in Torques between device head and extension (Page 52).
 - When mounting a SITRANS TS500 in full material design type 4 without flange (only Europe portfolio 7MC752..) of the device extension at the conduit, observe the required Torques between device extension and conduit (Page 52).

3.3 Mounting SITRANS TS300 in clamp-on design

Note

Measuring position

Only install on round pipes. Avoid an installation close to pipe elbows, sliders, valves, etc.

1. Determine the measuring position on the pipe.
2. Apply the thermal paste on the metal part of the temperature sensor.
3. For the standard design: Install the two sleeving parts to the pipe using two fixing screws. For the clamp design: Mount the SITRANS TS300 using a fixing screw.
 - If the process medium does not flow through the full cross-section of the pipe, mount the temperature sensor on the bottom of the pipe.

4. Tighten the fixing screws (tightening torque 4 Nm).
5. Mount the vibration protection and tighten it manually.
 - You can pull out the measuring insert by loosening the RTD recessed grip gland(s).
 - Do not twist the enclosure.
 - Only conduct the mounting work on the RTD recessed grip gland.
 - Do not apply any force to the transmitter (e.g. when opening and closing the cover).
 - Due to the seals being on the inside, the plug-in connectors are only suitable for an ambient temperature of up to 100 °C (212 °F).

3.4 Disassembly

 WARNING
Incorrect disassembly
The following risks may result from incorrect disassembly:
- Injury through electric shock
- Risk through emerging media when connected to the process
- Risk of explosion in hazardous area
In order to disassemble correctly, observe the following:
<ul style="list-style-type: none">• Before starting work, make sure that you have switched off all physical variables such as pressure, temperature, electricity etc. or that they have a harmless value.• If the device contains hazardous media, it must be emptied prior to disassembly. Make sure that no environmentally hazardous media are released.• Secure the remaining connections so that no damage can result if the process is started unintentionally.

Connecting

4.1 Basic safety notes

 WARNING
Unsuitable cables, cable glands and/or plugs Risk of explosion in hazardous areas. <ul style="list-style-type: none">• Use only cable glands/plugs that comply with the requirements for the relevant type of protection.• Tighten the cable glands in accordance with the torques specified in Technical data (Page 39).• Close unused cable inlets for the electrical connections.• When replacing cable glands, only use cable glands of the same type.• After installation, check that the cables are seated firmly.

 WARNING
Incorrect selection of type of protection Risk of explosion in areas subject to explosion hazard. This device is approved for several types of protection. <ol style="list-style-type: none">1. Decide in favor of one type of protection.2. Connect the device in accordance with the selected type of protection.3. In order to avoid incorrect use at a later point, make the types of protection that are not used permanently unrecognizable on the nameplate.

 WARNING
Improper power supply Risk of explosion in hazardous areas as result of incorrect power supply. <ul style="list-style-type: none">• Connect the device in accordance with the specified power supply and signal circuits. The relevant specifications can be found in the certificates, in Technical data (Page 39) or on the nameplate.

 WARNING
Lack of equipotential bonding Risk of explosion through compensating currents or ignition currents through lack of equipotential bonding. <ul style="list-style-type: none">• Ensure that the device is potentially equalized. Exception: It may be permissible to omit connection of the equipotential bonding for devices with type of protection "Intrinsic safety Ex i".

 WARNING
Unprotected cable ends Risk of explosion through unprotected cable ends in hazardous areas. <ul style="list-style-type: none">• Protect unused cable ends in accordance with IEC/EN 60079-14.

 WARNING
Loss of degree of protection When connecting the SITRANS TS100 or TS200 with type protection "Intrinsically safe", ensure the following: <ul style="list-style-type: none">• Adhere to the requirements for electrical connection separation.• Use IP54 rated enclosure.

 WARNING
Lemo plug in hazardous areas For Lemo plug version (7MC7xxx-xxxx2-xxx) make sure the cable ends are in an environment free from dust, water, or shock.

 WARNING
Improper laying of shielded cables Risk of explosion through compensating currents between hazardous area and the non-hazardous area. <ul style="list-style-type: none">• Shielded cables that cross into hazardous areas should be grounded only at one end.• If grounding is required at both ends, use an equipotential bonding conductor.

 WARNING**Connecting or disconnecting device in energized state**

Risk of explosion in hazardous areas.

- Connect or disconnect devices in hazardous areas only in a de-energized state.

Exceptions:

- Devices having the type of protection "Intrinsic safety Ex i" may also be connected in energized state in hazardous areas.

Note**Electromagnetic compatibility (EMC)**

You can use this device in industrial environments, households and small businesses.

For metal enclosures there is an increased electromagnetic compatibility compared to high-frequency radiation. This protection can be increased by grounding the enclosure.

See also

Connecting (Page 23)

Note**Improvement of interference immunity**

- Lay signal cables separate from cables with voltages > 60 V.
 - Use cables with twisted wires.
 - Keep device and cables at a distance from strong electromagnetic fields.
 - Take account of the conditions for communication specified in the Technical data (Page 39).
 - Use shielded cables to guarantee the full specification according to HART/PA/FF/Modbus/EIA-485/Profibus DP.
-

4.1.1 For SITRANS TSinsert

 WARNING
Flying leads Risk of explosion in hazardous areas due to loss of Intrinsic Safety protection. <ul style="list-style-type: none">• Shorten the ends of flying leads to the appropriate length.• Keep a minimal clearance of 2 mm between the wires of different circuits, or any circuit and the grounded enclosure. - or - Use heat shrinking tubes TFE-R 1/8": wall thickness ≥ 0.2 mm, di-electrical strength greater than 500 V.

4.1.2 For SITRANS TSinsert/TS100/TS200/TS500

NOTICE
Ambient temperature too high Damage to cable sheath. <ul style="list-style-type: none">• At an ambient temperature ≥ 60 °C (140 °F), use heat-resistant cables suitable for an ambient temperature at least 20 °C (36 °F) higher.

4.1.3 For SITRANS TS100/TS200

 WARNING
Use of plug connectors in explosive dust atmosphere Danger of explosion. Temperature sensors of the SITRANS TS100 and SITRANS TS200 series must not be used together with plug connectors in atmospheres with combustible dust. <ul style="list-style-type: none">• Do not use plug connectors in areas with combustible dust.

4.1.4 For SITRANS TS500

NOTICE

Condensation in the device

Damage to device through formation of condensation if the temperature difference between transportation or storage and the mounting location exceeds 20 °C (36 °F).

- Before taking the device into operation, let the device adapt for several hours in the new environment.

4.2 Connecting the device

Procedure

1. Loosen the fixing screws on the enclosure cover and remove the enclosure cover.
2. Insert the connecting cable through the cable gland.
3. Connect the wires to the relevant connecting terminals. Observe the terminal assignment:
 - Connecting the resistance thermometer (Page 27)
 - Connecting the thermocouple (Page 28)
 - Connecting the plug-in connector (Page 29)

See also

Electrical data (Page 53)

4.3 Connecting the resistance thermometer

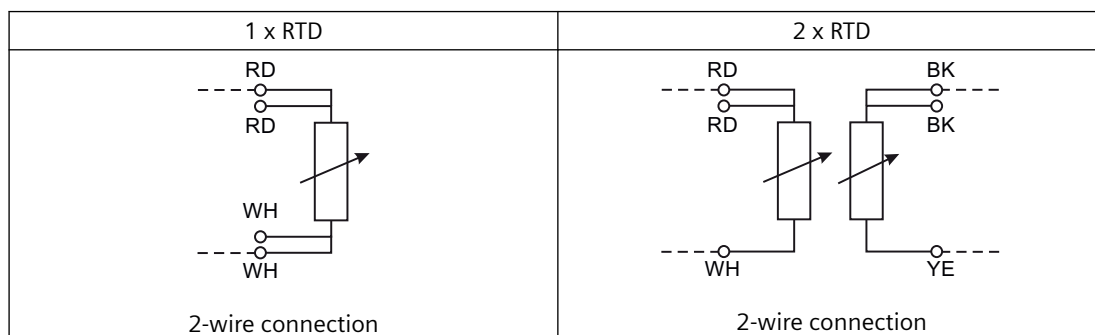

4.4 Connecting the thermocouple

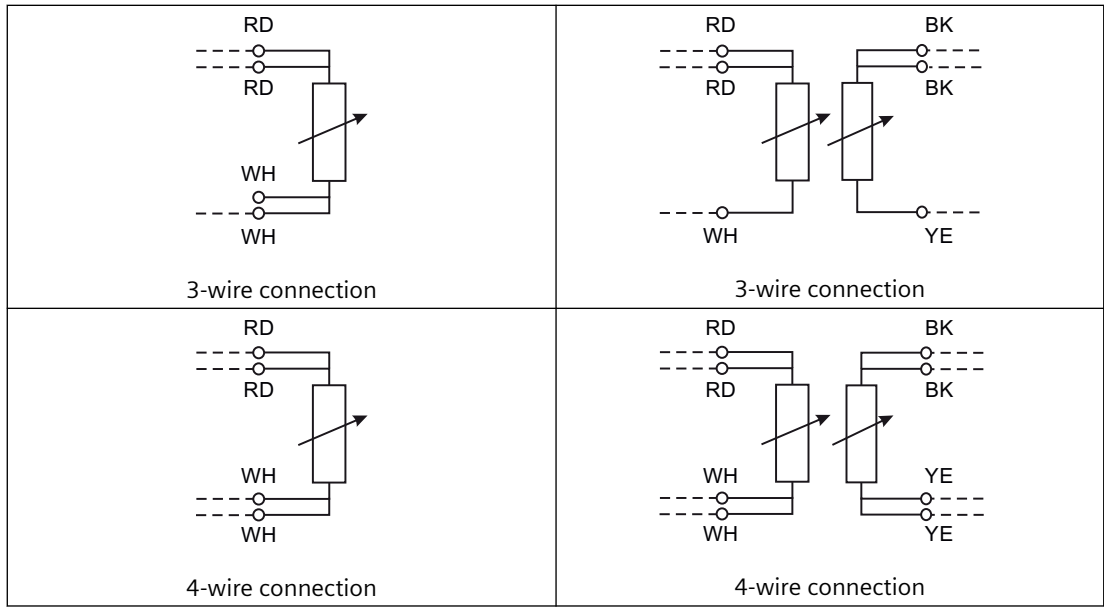

Abbreviation of color: RD = red; WH = white; YE = yellow; BK = black

4.4 Connecting the thermocouple

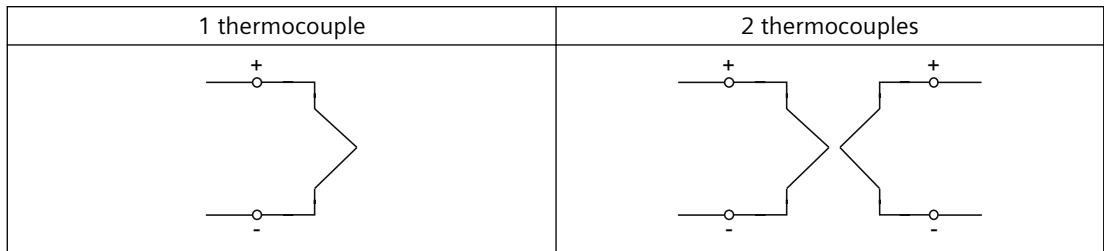

Thermocouples Type	Cable colors	
	+	-
J	Black	White
K	Green	White
N	Pink	White
E	Violet	White
T	Brown	White

Note

2 thermocouples

On the terminal block is an additional mark to differentiate between sensor 1 and sensor 2.

4.5 Connecting the plug-in connector

M12 x 1 connection with SITRANS TH100 transmitter

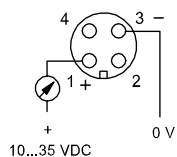

Lemo 1S connection for SITRANS TS100/TS200

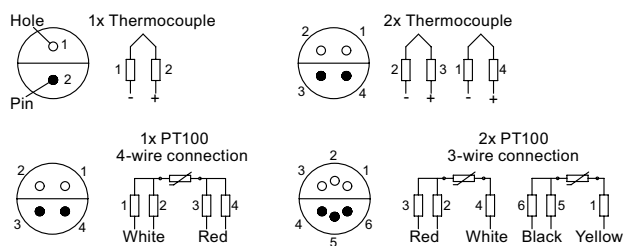

M12 connector for single sensor SITRANS TS100/TS200/TS500

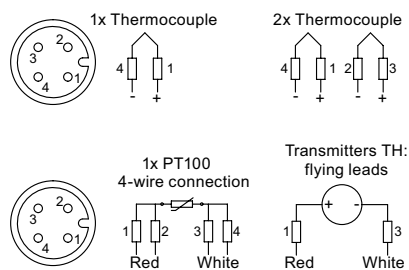

M12 connector for single sensor SITRANS TS300

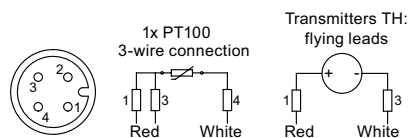

M12 connector for double sensor SITRANS TS100

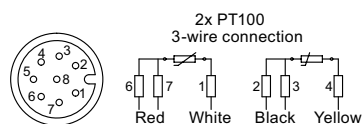

HAN7 D connector for SITRANS TS500

4.5 Connecting the plug-in connector

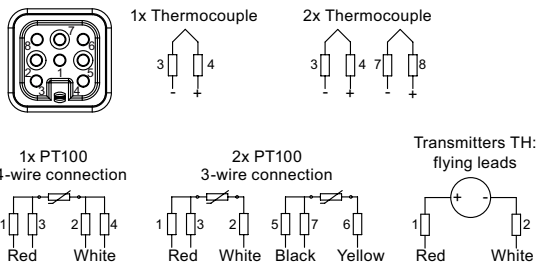

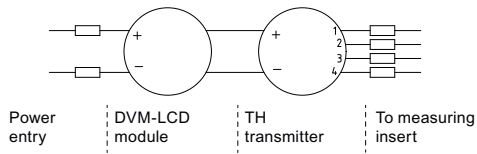

Connection of DVM-LCD and transmitter





Commissioning

5.1 Basic safety notes

 WARNING
<p>Improper commissioning in hazardous areas</p> <p>Device failure or risk of explosion in hazardous areas.</p> <ul style="list-style-type: none"> • Do not commission the device until it has been mounted completely and connected in accordance with the information in Installing/mounting (Page 15). • Before commissioning take the effect on other devices in the system into account.

 WARNING
<p>Hot surfaces</p> <p>Risk of burns resulting from hot surfaces.</p> <ul style="list-style-type: none"> • Take corresponding protective measures, for example by wearing protective gloves.

 WARNING
<p>Opening device in energized state</p> <p>Risk of explosion in hazardous areas</p> <ul style="list-style-type: none"> • Only open the device in a de-energized state. • Check prior to commissioning that the cover, cover locks, and cable inlets are assembled in accordance with the directives. <p>Exception: Devices having the type of protection "Intrinsic safety Ex i" may also be opened in energized state in hazardous areas.</p>

 WARNING
<p>Loss of explosion protection</p> <p>Danger of explosion in hazardous areas if the device is open or not properly closed.</p>

Note

Loss of degree of protection

Damage to device if the enclosure is open or not properly closed. The degree of protection specified on the nameplate is no longer guaranteed.

5.2 Commissioning

Requirements

Ensure that the following commissioning conditions are being met:

- You have connected the sensors correctly. For additional information, refer to:
 - Connecting the resistance thermometer (Page 27)
 - Connecting the thermocouple (Page 28)
- Ensure that the electrical connections are tightened with the correct torque.
- The following applies in particular for device versions with explosion protection:
 - Ensure that the cable glands are suitable for the process and have been tightened correctly.
 - The electrical data must match the specified ex-relevant values.
- All seals must be present, placed correctly and undamaged.

Procedure

1. Close the connection head. Fully screw on the cover for device versions with flameproof enclosures.
2. Connect the sensor integrated into the process to the power supply.

Service and maintenance

6.1 Basic safety notes

Note

The device is maintenance-free.

6.1.1 Maintenance

The device is maintenance-free. However, a periodic inspection according to pertinent directives and regulations must be carried out.

An inspection can include, for example, check of:

- Ambient conditions
- Seal integrity of the process connections, cable entries, and cover
- Reliability of power supply, lightning protection, and grounds

6.1.2 SITRANS TS500

 WARNING
--

Use of a computer in a hazardous area
--

If the interface to the computer is used in the hazardous area, there is a risk of explosion.

- | |
|---|
| <ul style="list-style-type: none"> • Ensure that the atmosphere is explosion-free (hot work permit). |
|---|

 WARNING
--

Dust layers above 5 mm

Risk of explosion in hazardous areas.

Device may overheat due to dust build up.

- | |
|---|
| <ul style="list-style-type: none"> • Remove dust layers in excess of 5 mm. |
|---|

 CAUTION
Releasing button lock Improper modification of parameters could influence process safety. <ul style="list-style-type: none">• Make sure that only authorized personnel may cancel the button locking of devices for safety-related applications.

NOTICE
Penetration of moisture into the device Damage to device. <ul style="list-style-type: none">• Make sure when carrying out cleaning and maintenance work that no moisture penetrates the inside of the device.

6.2 Cleaning

Cleaning the enclosure

- Clean the outside of the enclosure with the inscriptions and the display window using a cloth moistened with water or a mild detergent.
- Do not use any aggressive cleansing agents or solvents, e.g. acetone. Plastic parts or the painted surface could be damaged. The inscriptions could become unreadable.

See also

Cleaning (Page 34)

 WARNING
Electrostatic charge Risk of explosion in hazardous areas if electrostatic charges develop, for example, when cleaning plastic surfaces with a dry cloth. <ul style="list-style-type: none">• Prevent electrostatic charging in hazardous areas.

6.3 Maintenance and repair work

 WARNING**Impermissible repair and maintenance of the device**

- Repair and maintenance must be carried out by Siemens authorized personnel only.

 WARNING**Impermissible repair of explosion protected devices**

Risk of explosion in hazardous areas

- Repair must be carried out by Siemens authorized personnel only.

 WARNING**Impermissible accessories and spare parts**

Risk of explosion in areas subject to explosion hazard.

- Only use original accessories or original spare parts.
- Observe all relevant installation and safety instructions described in the instructions for the device or enclosed with the accessory or spare part.

 WARNING**Improper connection after maintenance**

Risk of explosion in areas subject to explosion hazard.

- Connect the device correctly after maintenance.
- Close the device after maintenance work.

Refer to Connecting (Page 23).

 WARNING**Humid environment**

Risk of electric shock.

- Avoid working on the device when it is energized.
- If working on an energized device is necessary, ensure that the environment is dry.
- Make sure when carrying out cleaning and maintenance work that no moisture penetrates the inside of the device.

6.3.1 SITRANS TS500

<p>⚠ CAUTION</p> <p>Hot surfaces</p> <p>Risk of burns during maintenance work on parts having surface temperatures exceeding 70 °C (158 °F).</p> <ul style="list-style-type: none"> • Take corresponding protective measures, for example by wearing protective gloves. • After carrying out maintenance, remount touch protection measures.
--

6.3.2 Service and maintenance

Recalibration

Temperature sensors are essentially maintenance-free. However, we recommend recalibration under the following conditions:

- Processes with strong vibrations or changes in temperature.
- Food, pharma, biotechnology applications (annually), TS300 only.
- Processes that demand high measuring accuracy and safety.

Note

Recalibration intervals

Define the recalibration intervals for the specific process or plant. With constant operating temperatures and a low load, the reference values are as follows:

- < 2 years at temperatures up to 400 °C
- < 5 years at temperatures up to 200 °C

Recalibration of SITRANS TS300

Description	Recalibration procedure
Clamp-on version	Do not disconnect the pipe sleeve from the pipe - leave the measuring position unchanged for reproducible measurement.
	It is not necessary to disconnect the power supply to perform calibration.
	Loosen recessed grip screw(s) to remove the RTD connector or housing and unscrew the measuring insert from the pipe collar.

Description	Recalibration procedure	
Block calibrators	Use calibrator sleeves that have been adapted to the shape of the RTD unit only.	
	Insert must have a borehole of $\varnothing 6.00$ mm (0.24") H7, depth = 8 mm (0.31").	
	Do not exceed 100 °C (212 °F) at locking plug [80 °C (176 °F) when using a temperature transmitter].	
	Use block calibrator with dual-zone-technology with internal reference sensor only.	
	Observe the adjustment time specified by the manufacturer when heating the calibrator.	
	1	Apply heat sink compound to the RTD unit before inserting it in the calibrator sleeve.
	2	Check the electrical connector (cable end) as indicated by the nameplate.
	3	After inserting the RTD unit, wait about 5 minutes for the temperature to settle.
Ohmic measurement	4	Compare the temperature of the calibrator with the RTD temperature and adjust if necessary.
	1	Take into account any line resistance.
	2	Apply heat sink compound to the RTD plug-in unit.

6.4 Return procedure

Enclose the bill of lading, return document and decontamination certificate in a clear plastic pouch and attach it firmly to the outside of the packaging.

Required forms

- Delivery note
- Return document (<http://www.siemens.com/processinstrumentation/returngoodsnote>) with the following information:
 - Product (item description)
 - Number of returned devices/replacement parts
 - Reason for returning the item(s)
- Decontamination declaration (<http://www.siemens.com/sc/declarationofdecontamination>)
 With this declaration you warrant "that the device/replacement part has been carefully cleaned and is free of residues. The device/replacement part does not pose a hazard for humans and the environment."
 If the returned device/replacement part has come into contact with poisonous, corrosive, flammable or water-contaminating substances, you must thoroughly clean and decontaminate the device/replacement part before returning it in order to ensure that all hollow areas are free from hazardous substances. Check the item after it has been cleaned. Any devices/replacement parts returned without a decontamination declaration will be cleaned at your expense before further processing.

6.5 Disposal

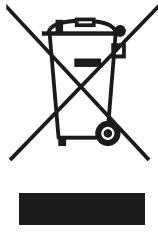

Devices described in this manual should be recycled. They may not be disposed of in the municipal waste disposal services according to the Directive 2012/19/EC on waste electronic and electrical equipment (WEEE).

Devices can be returned to the supplier within the EC, or to a locally approved disposal service for eco-friendly recycling. Observe the specific regulations valid in your country.

Further information about devices containing batteries can be found at: Information on battery/product return (WEEE) (<https://support.industry.siemens.com/cs/document/109479891/>)

Note

Special disposal required

The device includes components that require special disposal.

- Dispose of the device properly and environmentally through a local waste disposal contractor.
-

Technical data

7.1 Rated conditions

Storage	
Storage temperature	-40 ... +80 °C (-40 ... +176 °F)
Degree of protection in accordance with EN 60529	See nameplate. The degree of protection is achieved when the device is mounted correctly. See section Installing/mounting (Page 15).

7.1.1 Minimum permissible ambient temperatures in the connection area of the sensor

Sensor	Maximum permitted ambient temperatures in the connection area of the sensor
SITRANS TSinsert/TS100/TS200	-40 °C
SITRANS TS300	-20 °C
SITRANS TS500	
<ul style="list-style-type: none"> SITRANS TS500 SITRANS TS500 with SITRANS TH320/TH420 and display SITRANS TH100/TH200/TH300/TH400 with HAN 7D plug-in connector and M12 (option codes G12 and G13) 	-40 °C
SITRANS TS500 type 7MC75.. with header type AG0 and AU0 (option G and U) in non-SIL applications, without display, optional with installed SITRANS TH320/TH420	-50 °C
<ul style="list-style-type: none"> Electronics and cable glands of the SITRANS TS500 	<ul style="list-style-type: none"> Electronics and cable glands are designed for the minimum permissible ambient temperature of the SITRANS TS500. When the electronics or the cable gland are not designed for the minimum permissible ambient temperature, the minimum permissible ambient temperature of the entire SITRANS TS500 is reduced accordingly. See the datasheets of the electronics and the cable glands.

7.1 Rated conditions

7.1.2 Maximum permissible ambient temperatures in the connection area of the sensor

7.1.2.1 General limitations for compression fittings

Due to the PTFE sealing, standard compression fittings are limited to a maximum temperature of 200 °C.

7.1.2.2 SITRANS TS100

Note

Application SITRANS TS100

SITRANS TS100 temperature sensors are only approved for the temperature classes T4 and T6. Pay attention to the temperature resistance of the connection cables. See Ambient temperature too high (Page 26).

7.1.2.3 SITRANS TS500

	Gas		Dust
SITRANS TS500	in "intrinsic safety Ex i" - or - in "Non-sparking nA/ec"	in "flameproof enclosure (Ex d)"	is part of "intrinsic safety Ex i" - or - in "non-intrinsically safe circuits (Ex tb)"
Without electronics (only enclosure without terminal socket)	See header TS500 and relevant temperature class in Table 7-3 Gas Ex i/nA/ec (Page 45), Table 7-4 Gas Ex i/nA/ec (Page 46), Table 7-5 Type 2N (Page 46) and Table 7-6 Type 2N (Page 47).	See header TS500 without electronics in Table 7-7 Gas Ex d (Page 47) and Table 7-8 Type 2N (Page 48).	See header TS500 without electronics in Table 7-9 Dust Ex i/tb (Page 49) and Table 7-10 Type 2N (Page 50).
With temperature transmitters SITRANS TH or transmitters from third parties	$T_{a_max} = (T_1 - \Delta T2G) \leq T_2$ T_1 = see relevant certificate of the temperature transmitters. $\Delta T2G$ and T_2 = see Table 7-3 Gas Ex i/nA/ec (Page 45), Table 7-4 Gas Ex i/nA/ec (Page 46), Table 7-5 Type 2N (Page 46) and Table 7-6 Type 2N (Page 47).	See header TS500 with electronics in Table 7-7 Gas Ex d (Page 47) and Table 7-8 Type 2N (Page 48). When installing transmitters from third parties, observe the maximum permissible power consumption of 3 W.	See header TS500 with electronics in Table 7-9 Dust Ex i/tb (Page 49) and Table 7-10 Type 2N (Page 50). When installing transmitters from third parties, observe the maximum permissible power consumption of 1 W. The maximum surface temperature of the TS500 enclosure is assumed to be 85 °C. Notice! If the maximum permissible ambient temperature of the transmitters from third parties is less than 85 °C, run the following calculation: $T_{a_max} = T_1 - \Delta T1D - \Delta T2D$ T_1 = see relevant certificate of the temperature transmitters. $\Delta T1D = 22K$ (max. permissible power consumption of 1 W) $\Delta T2D =$ See Table 7-9 Dust Ex i/tb (Page 49) and Table 7-10 Type 2N (Page 50).

7.1 Rated conditions

	Gas		Dust
SITRANS TS500	in "intrinsic safety Ex i" - or - in "Non-sparking nA/ec"	in "flameproof enclosure (Ex d)"	is part of "intrinsic safety Ex i" - or - in "non-intrinsically safe circuits (Ex tb)"
With temperature transmitters SITRANS TH100/200/300 with DVM LCD (7MF4997-1BS)	$T_{a_max} = T_3 \leq T_2$ $T_3 =$ see Gas hazardous area Zone 1 / Div. 1 (Page 43). $T_2 =$ see Table 7-3 Gas Ex i/nA/ec (Page 45), Table 7-4 Gas Ex i/nA/ec (Page 46), Table 7-5 Type 2N (Page 46) and Table 7-6 Type 2N (Page 47).	See header TS500 with electronics in Table 7-7 Gas Ex d (Page 47) and Table 7-8 Type 2N (Page 48).	$T_{a_max} = T_3$ $T_3 =$ see Table 7-2 Dust hazardous area Zone 21 (Page 43).
With temperature transmitters SITRANS TH320/420 with display (7MF7902-1AD)	$T_{a_max} = T_3 \leq T_2$ $T_3 =$ see Table 7-1 Gas hazardous area Zone 1 (Page 43). $T_2 =$ see Table 7-3 Gas Ex i/nA/ec (Page 45), Table 7-4 Gas Ex i/nA/ec (Page 46), Table 7-5 Type 2N (Page 46) and Table 7-6 Type 2N (Page 47).	See header TS500 with electronics in Table 7-7 Gas Ex d (Page 47) and Table 7-8 Type 2N (Page 48).	$T_{a_max} = T_3$ $T_3 =$ see Table 7-2 Dust hazardous area Zone 21 (Page 43).

T_1 = Max. permissible ambient temperature of the temperature transmitter according to certificate

T_2 = Max. permissible ambient temperature of the respective connection head without transmitter

T_3 = Max. permissible ambient temperature SITRANS TH100/200/300 with DVM LCD (7MF4997-1BS) or SITRANS TH320/420 with display (7MF7902-1AD)

See also

SITRANS TH100/200/300 with DVM LCD or SITRANS TH320/420 with display (Page 43)

Gas hazardous area: Ex i / IS / Ex nA/ec / NI (Page 45)

Gas hazardous area: Ex d / XP (Page 47)

SITRANS TH100/200/300 with DVM LCD or SITRANS TH320/420 with display

You can find the values of ΔT_{2G} in the tables
 Table 7-3 Gas Ex i/nA/ec (Page 45),
 Table 7-4 Gas Ex i/nA/ec (Page 46),
 Table 7-5 Type 2N (Page 46) and
 Table 7-6 Type 2N (Page 47) and
 ΔT_{2D} in the table Table 7-9 Dust Ex i/tb (Page 49) and
 Table 7-10 Type 2N (Page 50).

Table 7-1 Gas hazardous area Zone 1

Permissible power supply parameters	T_3 = Permissible ambient temperature	
	Gas hazardous area Zone 1 / Div. 1: SITRANS TH100/200/300 with DVM LCD	Gas hazardous area Zone 1: SITRANS TH320/420 with display
$U_i = 30$ V DC $I_i = 120$ mA $L_i = 0$ μ H $C_i = 2.2$ nF $P_i = 900$ mW	-	T4: -40 ... +85 °C - ΔT_{2G} T5: -40 ... +65 °C - ΔT_{2G} T6: -40 ... +50 °C - ΔT_{2G}
$U_i = 30$ V $I_i = 100$ mA $P_i = 750$ mW	T4: -40 °C $\leq T_3 \leq$ +75 °C - ΔT_{2G} T6: -40 °C $\leq T_3 \leq$ +45 °C - ΔT_{2G}	T4: -40 ... +85 °C - ΔT_{2G} T5: -40 ... +70 °C - ΔT_{2G} T6: -40 ... +55 °C - ΔT_{2G}
$U_i = 27$ V $I_i = 90$ mA $P_i = 610$ mW	T4: -40 °C $\leq T_3 \leq$ +85 °C - ΔT_{2G} T6: -40 °C $\leq T_3 \leq$ +50 °C - ΔT_{2G}	T4: -40 ... +85 °C - ΔT_{2G} T5: -40 ... +75 °C - ΔT_{2G} T6: -40 ... +60 °C - ΔT_{2G}
$U_i = 25.2$ V $I_i = 84$ mA $P_i = 530$ mW	T4: -40 °C $\leq T_3 \leq$ +85 °C - ΔT_{2G} T6: -40 °C $\leq T_3 \leq$ +52 °C - ΔT_{2G}	-

Table 7-2 Dust hazardous area Zone 21

Permissible power supply parameters	T_3 = Permissible ambient temperature	
	Gas hazardous area Zone 1 / Div. 1: SITRANS TH100/200/300 with DVM LCD	Gas hazardous area Zone 1: SITRANS TH320/420 with display
$U_i = 30$ V DC $I_i = 120$ mA $L_i = 0$ μ H $C_i = 2.2$ nF $P_i = 900$ mW	-	T4: -40 ... +85 °C - ΔT_{2G} T5: -40 ... +65 °C - ΔT_{2G} T6: -40 ... +50 °C - ΔT_{2G}
$U_i = 30$ V $I_i = 100$ mA $P_i = 750$ mW	T85 °C: -40 °C $\leq T_3 \leq$ +53 °C - ΔT_{2D}	T4: -40 ... +85 °C - ΔT_{2G} T5: -40 ... +70 °C - ΔT_{2G} T6: -40 ... +55 °C - ΔT_{2G}

Technical data

7.1 Rated conditions

Permissible power supply parameters	$T_3 =$ Permissible ambient temperature	
	Gas hazardous area Zone 1 / Div. 1: SITRANS TH100/200/300 with DVM LCD	Gas hazardous area Zone 1: SITRANS TH320/420 with display
$U_i = 27 \text{ V}$ $I_i = 90 \text{ mA}$ $P_i = 610 \text{ mW}$	T85 °C: $-40 \text{ °C} \leq T_3 \leq +63 \text{ °C} - \Delta T2D$	T4: $-40 \dots +85 \text{ °C} - \Delta T2G$ T5: $-40 \dots +75 \text{ °C} - \Delta T2G$ T6: $-40 \dots +60 \text{ °C} - \Delta T2G$
$U_i = 25.2 \text{ V}$ $I_i = 84 \text{ mA}$ $P_i = 530 \text{ mW}$	T85 °C: $-40 \text{ °C} \leq T_3 \leq +63 \text{ °C} - \Delta T2D$	-

See also

Gas hazardous area: Ex i / IS / Ex nA/ec / NI (Page 45)

Dust hazardous area: Ex i / IS / Ex tb / DIP (Page 49)

Gas hazardous area: Ex i / IS / Ex nA/ec / NI

The maximum ambient temperatures T_2 of the respective connection head **without transmitter** can be found in the cells of the following tables. The temperature rise caused by the medium is already taken into account in the tables.

Table 7-3 Gas Ex i/nA/ec

Header type			AU0		AV0, SITRANS TF		BA0: BB0; BC0; BD0; AA0, AB0, AC0, KJ0, BS0, AG0	
T_{max} Header			120 °C		85 °C		100 °C	
Temperature class			T4	T6	T4	T6	T4	T6
Temperature of medium (°C)	Temperature rise caused by medium ΔT_{2G} (K)	Extension length "X" (mm)	T_2 in °C	T_2 in °C	T_2 in °C	T_2 in °C	T_2 in °C	T_2 in °C
440 °C	23	40	97	57	62	57	77	57
	12	80	108	68	73	68	88	68
	6	150	114	74	79	74	94	74
	3	300	117	77	82	77	97	77
290 °C	22	40	98	58	63	58	78	58
	11	80	109	69	74	69	89	69
	5	150	115	75	80	75	95	75
	2	300	118	78	83	78	98	78
200 °C	16	40	104	64	69	64	84	64
	8	80	112	72	77	72	92	72
	4	150	116	76	81	76	96	76
	2	300	118	78	83	78	98	78
130 °C	9	40	111	71	76	71	91	71
	5	80	115	75	80	75	95	75
	3	150	117	77	82	77	97	77
	1	300	119	79	84	79	99	79
80 °C	5	40	120	80	85	80	100	80
	3	80	120	80	85	80	100	80
	1	150	120	80	85	80	100	80
	0	300	120	80	85	80	100	80

Technical data

7.1 Rated conditions

Table 7-4 Gas Ex i/nA/ec

Header type				BT0, AH0	BMO	BPO	
T _{max} Header				80 °C	80 °C	100 °C	
Temperature class				T6	T6	T4	T6
Temperature of medium (°C)	Temperature rise caused by medium ΔT2G (K)		Extension length "X" (mm)	T ₂ in °C	T ₂ in °C	T ₂ in °C	T ₂ in °C
440 °C	23	43*	40	57	37	57	37
	12	23*	80	68	57	77	57
	6	11*	150	74	69	89	69
	3		300	77	77	97	77
290 °C	22		40	58	58	78	58
	11		80	69	69	89	69
	5		150	75	75	95	75
	2		300	78	78	98	78
200 °C	16		40	64	64	84	64
	8		80	72	72	92	72
	4		150	76	76	96	76
	2		300	78	78	98	78
130 °C	9		40	71	71	91	71
	5		80	75	75	95	75
	3		150	77	77	97	77
	1		300	79	79	99	79
80 °C	5		40	80	80	100	80
	3		80	80	80	100	80
	1		150	80	80	100	80
	0		300	80	80	100	80

* Value for header type BPO and BMO

Table 7-5 Type 2N

Header type			AU0	AV0, SITRANS TF		
T _{max} Header			120 °C	85 °C		
Temperature class			T4	T6	T4	T6
Temperature of medium (°C)	Temperature rise caused by medium ΔT2G (K)		T ₂ in °C	T ₂ in °C	T ₂ in °C	T ₂ in °C
100 °C	7		120	73	78	73
80 °C	5		120	80	85	80

Table 7-6 Type 2N

Header type		BA0: BB0; BC0; BD0; AA0, AB0, AC0, KJ0, BS0, AG0	BMO, BT0, AH0	BP0		
T _{max} Header		100 °C		80 °C	100 °C	
Temperature class		T4	T6	T6	T4	T6
Temperature of medium (°C)	Temperature rise caused by medium ΔT2G (K)	T ₂ in °C	T ₂ in °C	T ₂ in °C	T ₂ in °C	T ₂ in °C
100 °C	7	100	73	73	100	73
80 °C	5	100	80	80	100	80

Gas hazardous area: Ex d / XP

The maximum ambient temperatures T_a for the respective connection head **with or without transmitter** can be obtained from the cells in the following tables. The temperature increase given by the medium is already considered there.

Table 7-7 Gas Ex d

Head type		AH0, AV0, SI-TRANS TF	AG0, UG0		AU0, UU0	
T _{max} head		85 °C	100 °C		120 °C	
Temperature class		T6	T4		T3	T4
Max. permitted power consumption of electronic (W)		0 ... 3 ¹⁾ With or without electronic	0 Without electronic	1 ... 3 ¹⁾ With electronic	0 Without electronic	1 ... 3 ¹⁾ With electronic
Medium temperature (°C)	Extension length "X" (mm)	T _{a,max} in °C	T _{a,max} in °C	T _{a,max} in °C	T _{a,max} in °C	T _{a,max} in °C
440 °C	40	43	76	53	96	48
	80	55	88	65	108	60
	150 ... 300	61	94	71	114	66
290 °C	40	54	87	64	107	59
	80 ... 300	61	94	71	114	66
200 °C	40	58	91	68	111	63
	80 ... 300	63	96	73	116	68
130 °C	40 ... 300	61	94	71	114	66
80 °C	40 ... 300	67	100	77	120	72

¹⁾ For the determination of ambient temperatures, maximum enclosure temperature of 85 °C was taken as a basis when electronic are incorporated.

7.1 Rated conditions

Table 7-8 Type 2N

Head type		AH0, AV0, SI-TRANS TF	AG0, UG0		AU0, UU0	
T_{max} head		85 °C	100 °C		120 °C	
Temperature class		T6	T4		T3	T4
Max. permitted power consumption of electronic (W)		0 ... 3 ¹⁾ With or without electronic	0 Without electronic	1 ... 3 ¹⁾ With electronic	0 Without electronic	1 ... 3 ¹⁾ With electronic
Medium temperature (°C)		T_{a_max} in °C	T_{a_max} in °C	T_{a_max} in °C	T_{a_max} in °C	T_{a_max} in °C
100 °C		60	100	70	120	65
80 °C		67	100	77	120	72

¹⁾ For the determination of ambient temperatures, maximum enclosure temperature of 85 °C was taken as a basis when electronic are incorporated.

Dust hazardous area: Ex i / IS / Ex tb / DIP

The maximum ambient temperatures T_a for the respective connection head **with or without transmitter** can be obtained from the cells in the following tables. The temperature increase given by the medium is already considered there.

Table 7-9 Dust Ex i/tb

Head type			AH0, AV0, SITRANS TF		AG0, UG0		AU0, UU0	
T_{max} head			85 °C		100 °C		120 °C	
Max. permitted power consumption of electronic (W)			0 Without electronic	1 ¹⁾ With elec- tronic	0 Without electronic	1 ¹⁾ With elec- tronic	0 Without electronic	1 ¹⁾ With elec- tronic
Medium temperature (°C)	Temperature increase by Medium ΔT_{2D} (K)	Extension length "X" (mm)	T_{a_max} in °C	T_{a_max} in °C	T_{a_max} in °C	T_{a_max} in °C	T_{a_max} in °C	T_{a_max} in °C
440 °C	36	40	49	--	64	--	84	--
	18	80	67	45	82	45	102	45
	8	150	77	55	92	55	112	55
	4	300	81	59	96	59	116	59
250 °C	22	40	63	--	78	--	98	--
	11	80	74	52	89	52	109	52
	5	150	80	58	95	58	115	58
	1	300	84	62	99	62	119	62
120 °C	10	40	75	53	90	53	120	53
	5	80	80	58	95	58	120	58
	3	150	82	60	97	60	120	60
	0	300	85	63	100	63	120	63

¹⁾ Assembled temperature transmitter e.g. SITRANS TH without Display

7.1 Rated conditions

Table 7-10 Type 2N

Head type		AH0, AV0, SITRANS TF		AG0, UG0		AU0, UU0	
T _{max} head		T85 °C		100 °C		120 °C	
Max. permitted power consumption of electronic (W)		0 Without electronic	1 ¹⁾ With electronic	0 Without electronic	1 ¹⁾ With electronic	0 Without electronic	1 ¹⁾ With electronic
Medium temperature (°C)	Temperature increase by Medium ΔT2D (K)	T _{a_max} in °C	T _{a_max} in °C	T _{a_max} in °C	T _{a_max} in °C	T _{a_max} in °C	T _{a_max} in °C
100 °C	10	75	53	100	53	120	53
80 °C	8	85	63	100	63	120	63

¹⁾ Assembled temperature transmitter for example SITRANS TH

7.1.3 Maximum permitted sample temperatures within the process

Note

Permissible ambient temperature at sensor

The maximum permissible ambient temperature at the sensor simultaneously corresponds to the highest permissible sample temperature.

The minimum permissible sample temperatures are up to -200 °C depending on the version of the temperature sensor.

See also

Maximum permitted sample temperatures within the process (Page 50)

Resistance thermometers

Table 7-11 RTD temperature sensor (R_{th} max=120 K/W)

1 x RTD TF/3 mm/6 mm 2 x RTD TF/3 mm/6 mm 1 x RTD WW/3 mm/6 mm 2 x RTD WW/3 mm/6 mm	Max. permissible sample temperature (°C)			
	Certified transmitter in Zone 0 with type of protection "Intrinsically safe"		Certified transmitter in Zone 1, 2 with type of protection "Intrinsically safe"	
	P0: 0 ... ≤37 mW ¹⁾	P0: ≥37 ... ≤100 mW	P0: 0 ... ≤37 mW ¹⁾	P0: ≥37 ... ≤100 mW
T1 = 450 °C -10K	348	340	436	428
T2 = 300 °C -10K	228	220	286	278
T3 = 200 °C - 5K	152	144	191	183

1 x RTD TF/3 mm/6 mm 2 x RTD TF/3 mm/6 mm 1 x RTD WW/3 mm/6 mm 2 x RTD WW/3 mm/6 mm	Max. permissible sample temperature (°C)			
	Certified transmitter in Zone 0 with type of protection "Intrinsically safe"		Certified transmitter in Zone 1, 2 with type of protection "Intrinsically safe"	
	P0: 0 ... ≤37 mW ¹⁾	P0: ≥37 ... ≤100 mW	P0: 0 ... ≤37 mW ¹⁾	P0: ≥37 ... ≤100 mW
T4 = 135 °C - 5K	100	92	126	118
T6 = 85 °C - 5K	60	52	76	68

¹⁾ For example SITRANS TH

Thermocouples

Table 7-12 Thermocouple temperature sensor ($R_{th, max}=15$ K/W)

1 x TC type J, K, N /3 mm 2 x TC type J, K, N /3 mm 1 x TC type J, K, N /6 mm 2 x TC type J, K, N /6 mm	Max. permissible sample temperature (°C)	
	Certified transmitter in Zone 0 with type of protection "Intrinsically safe"	Certified transmitter in Zone 1, 2 with type of protection "Intrinsically safe"
	P0: 0 ... 100 mW	
T1 = 450 °C -10K	351	439
T2 = 300 °C -10K	231	289
T3 = 200 °C -5K	155	194
T4 = 135 °C -5K	103	129
T6 = 85 °C -5K	63	79

7.1.4 Measuring range

The measuring range refers to the temperature limits in which the thermometer can be used practically for measuring purposes. Depending on the loads at the place of use and the required accuracies, the actual measuring range may decrease.

Note

Measuring ranges

The application or possible operating temperatures depend on the configuration of the temperature sensor.

7.2 Construction

Table 7-13 Torque values for M20 accessories

Torques for M20 accessories	Plastic header	Metal header	Cable cross-section
Cable gland made of plastic	5.0 Nm	5.0 Nm	6 ... 12 mm
Cable gland made of metal	-/-	5.0 Nm	5 ... 14 mm
Adapter M20 to NPT½	5.0 Nm	5.0 Nm	-/-

SITRANS TS500 with header type A requires a minimum thickness of the open-ended wrench of 5 mm. The maximum wrench size is SW24.

Table 7-14 Torques between device extension and conduit

Connection type	Tightening torque
Thread M14	25 Nm
Thread M18	40 Nm
Thread G½; thread M20	50 Nm
½ Inch NPT	Hand-tight and one to two complete rotations with a wrench

Table 7-15 Torques between device header and extension

Header type	Tightening torque
Metal header	20 Nm
Plastic header	5 Nm

Table 7-16 Estimation of immersion depth

Process medium	Immersion depth (calculation) ¹⁾
Water	Immersion depth \geq TSL ¹⁾ + (5 x $\varnothing_{conduit}$)
Air	Immersion depth \geq TSL ¹⁾ + (10 to 15 x $\varnothing_{conduit}$)

¹⁾ TSL = Temperature-sensitive length

Table 7-17 Maximum core cross-section

SITRANS TH	SITRANS TR	SITRANS TF
1 x 1.5 mm ² (AWG 13)	2.5 mm ² (AWG 13)	Single chamber housing: 1.5 mm ² (AWG 13) Dual chamber housing: 2.5 mm ² (AWG 13)

7.3 Electrical data

Devices for general use

Measured current	
$I_{\text{Measuring}}$ (Pt 100)	0.3 ... 1.0 mA
$I_{\text{Measuring}}$ (Pt 1000)	0.1 ... 0.3 mA

Devices in explosion-protected version

Equipment protection by means of intrinsic safety	
For connecting to circuits with the following peak values	$U_i \leq 30 \text{ V}$ $I_i \leq 100 \text{ mA}$ $P_i = P_o$ (transmitter) $C_i = 700 \text{ pF/m}$ $L_i = 15 \text{ }\mu\text{H/m}$

Equipment protection by means of non incensive	
For connecting to circuits with the following peak values	$U_n = 30 \text{ V}$ $U_{\text{max}} = 32 \text{ V}^{1)}$

¹⁾ Maximum safety voltage

Equipment protection by means of Explosionproofed / Dust-Ignition proofed	
For connecting to circuits with the following peak values	$U_{\text{max}} = 45 \text{ V}$ $(U_{\text{max}} = 35 \text{ V for USA/Canada)}$ $P = 25/37/50/100 \text{ mW}$

Effective internal capacitance and internal inductance

	Display	SITRANS TH100	Σ
C_i	16 nF	13 nF	29 nF
L_i	3 μH	106 μH	109 μH

7.4 Certificates and approvals

You can find certificates on the Internet at Certificates (<http://www.siemens.com/processinstrumentation/certificates>) or on an included DVD.

7.4.1 SITRANS TSInsert/TS100/TS200/TS500

SITRANS TSInsert/TS100/TS200/TS500	
"Intrinsic safety ia/ib" type of protection "Non-sparking nA/ec" type of protection	
ATEX/IECEX PTB 09 ATEX 2014 X IECEX PTB 11.0010 X	II 1 D Ex ia IIIC T 200 °C Da II 1 G Ex ia IIC T6 / T4 ... T1 Ga II 3 G Ex ic IIC T6 / T4 ... T1 Gc II 3 G Ex ec IIC T6 / T4 ... T1 Gc II 3 G Ex nA IIC T6 / T4 ... T1 Gc
NEPSI GYJ14.1005X	Ex iaD 20 T200 Ex ibD 21 T200 Ex ia IIC T1/T2/T3/T4/T6 Ga Ex ib IIC T1/T2/T3/T4/T6 Gb Ex ic IIC T1/T2/T3/T4/T6 Gc
EACEX RU C-DE.AA87.B.00006	Ex ia IIIC T200 °C Da X 0Ex ia IIC T6/T4 ...T1 Ga X 2Ex ic IIC T6/T4 ... T1 Gc X
cCSAus 70037146	Class I, Division 1, Groups A, B, C, D T6/T4 ... T1 Class I, Division 2, Groups A, B, C, D T6/T4 ... T1 Class II Division 1 Groups E, F, G T6/T4 ... T1 Class II Division 2 Groups F, G T6/T4 ... T1 Class III Ex ia IIC T6/T4 ... T1 Ga Ex ia IIIC T200 °C Da AEx ia IIC T6/T4 ... T1 Ga AEx ia IIIC T200 °C Da Ex ic IIC T6/T4 ... T1 Gc Class I, Zone 2, AEx ic IIC T6/T4 ... T1 Gc

7.4.2 SITRANS TS500

SITRANS TS500	
"Flameproof enclosure Ex d dust explosion protection by enclosure Ex tb/tc" type of protection	
ATEX/IECEX PTB 10 ATEX 1005 X IECEX PTB 10.0018 X	II 1/2 G Ex d IIC T6, T4, T3 Ga/Gb II 1/2 D Ex tb IIIC T85 °C, 100 °C or 150 °C
NEPSI GYJ14.1004X	Ex d IIC T3/T4/T6 Ga/Gb DIP A20/21 TA85 °C/100 °C/150 °C IP65

SITRANS TS500

EACEx RU C-DE.AA87.B.00006	Ga/Gb Ex d IIC, T6, T4, T3 X Ex tb IIIC T85 °C, T100 °C, T150 °C Da/Db X
cCSAus 70037146	Class I, Division 1, Groups A, B, C, D T6, T4 ... T1 Class I, Division 1, Groups B, C, D T6, T4 ... T1 (type code 7MC65...-.....-. (G;U)..) Class I, Division 2, Groups A, B, C, D T6, T4 ... T1 Class II Division 1 Groups E, F, G T6, T4 ... T1 Class II Division 2 Groups F, G T6, T4 ... T1 Class III Ex d IIC T6, T4, T3 Ga/Gb Ex tb IIIC T85 °C, T100 °C, T150 °C Da/Db AEx tb IIIC T85 °C, T100 °C, T150 °C Da/Db
cFMus FM17US0010X (USA) FM17CA0005X (Canada)	Class I Division 1, Groups A, B, C, D; T* Ta = -40 °C up to +Tx °C Class II, III, Division 1, Groups E, F, G; T* Ta = -40 °C up to +Tx °C Class I, II, III, Division 2, Group A, B, C, D, F, G; T* Ta = -40 °C up to +Tx °C Class I, Zone 1, AEx d IIC T* Gb Ta = -40 °C up to +Tx °C (only FMus) Class I, Zone 1, Ex d IIC T* Gb Ta = -40 °C up to +Tx °C (only cFM) Zone 21 AEx tb IIIC T* Db Ta = -40 °C up to +Tx °C (only FMus) Ex tb IIIC T* Db Ta = -40 °C up to +Tx °C (only cFM) Type 4X, IP66/67

Product documentation and support

A.1 Product documentation

Process instrumentation product documentation is available in the following formats:

- Certificates (<http://www.siemens.com/processinstrumentation/certificates>)
- Downloads (firmware, EDDs, software) (<http://www.siemens.com/processinstrumentation/downloads>)
- Catalog and catalog sheets (<http://www.siemens.com/processinstrumentation/catalogs>)
- Manuals (<http://www.siemens.com/processinstrumentation/documentation>)
You have the option to show, open, save, or configure the manual.
 - "Display": Open the manual in HTML5 format
 - "Configure": Register and configure the documentation specific to your plant
 - "Download": Open or save the manual in PDF format
 - "Download as html5, only PC": Open or save the manual in the HTML5 view on your PC

You can also find manuals with the Mobile app at Industry Online Support (<https://support.industry.siemens.com/cs/ww/de/sc/2067>). Download the app to your mobile device and scan the device QR code.

Product documentation by serial number

Using the PIA Life Cycle Portal, you can access the serial number-specific product information including technical specifications, spare parts, calibration data, or factory certificates.

Entering a serial number

1. Open the PIA Life Cycle Portal (<https://www.pia-portal.automation.siemens.com>).
2. Select the desired language.
3. Enter the serial number of your device. The product documentation relevant for your device is displayed and can be downloaded.

To display factory certificates, if available, log in to the PIA Life Cycle Portal using your login or register.

Scanning a QR code

1. Scan the QR code on your device with a mobile device.
2. Click "PIA Portal".

To display factory certificates, if available, log in to the PIA Life Cycle Portal using your login or register.

A.2 Technical support

Technical support

If this documentation does not completely answer your technical questions, you can enter a Support Request (<http://www.siemens.com/automation/support-request>).

Additional information on our technical support can be found at Technical Support (<http://www.siemens.com/automation/csi/service>).

Service & support on the Internet

In addition to our technical support, Siemens offers comprehensive online services at Service & Support (<http://www.siemens.com/automation/serviceandsupport>).

Contact

If you have further questions about the device, contact your local Siemens representative at Personal Contact (<http://www.automation.siemens.com/partner>).

To find the contact for your product, go to "all products and branches" and select "Products & Services > Industrial automation > Process instrumentation".

Contact address for business unit:

Siemens AG
Digital Industries
Process Automation
Östliche Rheinbrückenstr. 50
76187 Karlsruhe, Germany

A.3 QR code label

A QR code label can be found on the device. With the use of a smart phone, the QR code provides a direct link to a website with information specific to the device, such as manuals, FAQs, certificates, etc.

Index

C

Cable colors for thermocouple, 28
Catalog
 catalog sheets, 57
Certificates, 9, 53, 57
Cleaning, 34
Customer Support, (Refer to Technical support)

D

Disassembly, 21
Disposal, 38
Document history, 5
Documentation
 Edition, 5
Downloads, 57
Dust, 49

H

Hazardous area
 Laws and directives, 9
 Qualified personnel, 11
Hotline, (Refer to Support request)

L

Laws and directives
 Disassembly, 9
 Personel, 9

M

Maintenance, 33
Manuals, 57
Modifications
 correct usage, 10
 improper, 10
Mounting position
 Pickup, 20

P

Process connection, 19

Q

QR code label, 58
Qualified personnel, 11

R

Recalibration, 36
Resistance thermometers
 Connecting, 28
Return procedure, 37

S

Scope of delivery, 6
Service, 58
Service and support
 Internet, 58
Support, 58
Support request, 58

T

Technical support, 58
 partner, 58
 personal contact, 58
Test certificates, 9
Thermocouple
 Cable colors, 28
 Connecting, 28

W

Warranty, 7

