

Coriolis flowmeters

SITRANS F C MASS 2100 Di 1.5

Operating Instructions • 03/2011



SITRANS F

SIEMENS

SIEMENS

SITRANS F

Coriolis Flowmeters SITRANS F C MASS 2100 DI 1.5

Operating Instructions

<u>Introduction</u>	1
<u>Safety notes</u>	2
<u>Description</u>	3
<u>Installing/Mounting</u>	4
<u>Connecting</u>	5
<u>Commissioning</u>	6
<u>Service and maintenance</u>	7
<u>Technical data</u>	8

Coriolis flow sensor designed for use with flow transmitters of the type SITRANS F C MASS 6000 or SIFLOW FC070

Legal information

Warning notice system

This manual contains notices you have to observe in order to ensure your personal safety, as well as to prevent damage to property. The notices referring to your personal safety are highlighted in the manual by a safety alert symbol, notices referring only to property damage have no safety alert symbol. These notices shown below are graded according to the degree of danger.

⚠ DANGER
indicates that death or severe personal injury will result if proper precautions are not taken.
⚠ WARNING
indicates that death or severe personal injury may result if proper precautions are not taken.
⚠ CAUTION
with a safety alert symbol, indicates that minor personal injury can result if proper precautions are not taken.
CAUTION
without a safety alert symbol, indicates that property damage can result if proper precautions are not taken.
NOTICE
indicates that an unintended result or situation can occur if the corresponding information is not taken into account.

If more than one degree of danger is present, the warning notice representing the highest degree of danger will be used. A notice warning of injury to persons with a safety alert symbol may also include a warning relating to property damage.

Qualified Personnel

The product/system described in this documentation may be operated only by **personnel qualified** for the specific task in accordance with the relevant documentation for the specific task, in particular its warning notices and safety instructions. Qualified personnel are those who, based on their training and experience, are capable of identifying risks and avoiding potential hazards when working with these products/systems.

Proper use of Siemens products

Note the following:

⚠ WARNING
Siemens products may only be used for the applications described in the catalog and in the relevant technical documentation. If products and components from other manufacturers are used, these must be recommended or approved by Siemens. Proper transport, storage, installation, assembly, commissioning, operation and maintenance are required to ensure that the products operate safely and without any problems. The permissible ambient conditions must be adhered to. The information in the relevant documentation must be observed.

Trademarks

All names identified by ® are registered trademarks of the Siemens AG. The remaining trademarks in this publication may be trademarks whose use by third parties for their own purposes could violate the rights of the owner.

Disclaimer of Liability

We have reviewed the contents of this publication to ensure consistency with the hardware and software described. Since variance cannot be precluded entirely, we cannot guarantee full consistency. However, the information in this publication is reviewed regularly and any necessary corrections are included in subsequent editions.

Table of contents

1	Introduction.....	5
1.1	Items supplied.....	5
1.2	Document history.....	6
1.3	Further Information.....	6
1.4	Notes on warranty.....	7
2	Safety notes.....	9
2.1	Laws and directives.....	9
2.2	Installation in hazardous area.....	10
2.3	Certificates.....	12
3	Description.....	13
3.1	Design.....	13
3.2	Theory of operation.....	14
4	Installing/Mounting.....	17
4.1	Installation safety precautions.....	17
4.2	Determining a location.....	18
4.3	Orienting the sensor.....	19
4.4	Mounting the sensor.....	21
4.5	Orienting the multiple plug connector.....	23
4.6	Mounting a pressure guard.....	24
5	Connecting.....	27
5.1	Safety precautions.....	27
5.2	Wiring.....	28
6	Commissioning.....	29
6.1	Zero point adjustment.....	29
7	Service and maintenance.....	31
7.1	Maintenance.....	31
7.2	Transportation and storage.....	31
7.3	Recalibration.....	31
7.4	Technical support.....	32
7.5	Return procedures.....	33

8	Technical data	35
8.1	Measurement range	35
8.2	Performance.....	36
8.3	Accuracy.....	37
8.4	Rated operating conditions	38
8.5	Pressure drop.....	39
8.6	Pressure / temperature range	40
8.7	Design	42
8.8	Dimensions	43
8.9	Electrical connection schematics	45
8.10	Approvals and certificates	46
8.11	Ordering	46
	Glossary	47
	Index.....	51

Introduction

These instructions contain all information required to commission and use the device. It is your responsibility to read the instructions carefully prior to installation and commissioning. In order to use the device correctly, first review its principle of operation.

The instructions are aimed at persons mechanically installing the device, connecting it electronically, configuring the parameters and commissioning it, as well as service and maintenance engineers.

1.1 Items supplied

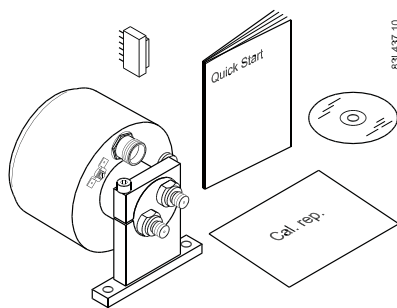

Items supplied

- SITRANS F C MASS 2100 DI 1.5
- Sensorprom Memory unit
- Mounting bracket
- Calibration certificate
- Quick Start Guide
- SITRANS F C literature CD

Inspection

1. Check for visual mechanical damage due to possible improper handling during shipment. All claims for damage are to be made promptly to the carrier.
2. Make sure the scope of delivery, and the information on the type plate corresponds to your order and the delivery note.

Identification

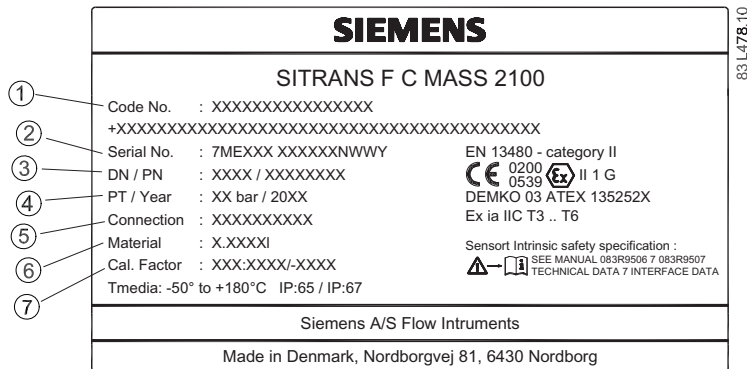

- | | | |
|---|---------------|---------------------------------------------------------|
| ① | Code number | Device specific code number |
| ② | Serial number | Device specific serial number |
| ③ | DN / PN | Process connector nominal size / sensor pressure rating |
| ④ | PT / Year | Test pressure and time stamp |
| ⑤ | Connection | Process connector |
| ⑥ | Material | Material of the pipe |
| ⑦ | Cal. factor | Device specific calibration factor |

Figure 1-1 MASS 2100 Type plate

1.2 Document history

The contents of these instructions are regularly reviewed and corrections are included in subsequent editions. We welcome all suggestions for improvement.

The following table shows the most important changes in the documentation compared to each previous edition.

Edition	Remarks
03/2011	First edition: <ul style="list-style-type: none"> Replaces MASS 2100 DI 1.5 Instructions (09/2003, SFIDK.PI.M2.52)

1.3 Further Information

Product information on the Internet

The Operating Instructions are available on the CD-ROM shipped with the device, and on the Internet on the Siemens homepage, where further information on the range of SITRANS F flowmeters may also be found:

Product information on the internet (<http://www.siemens.com/flowdocumentation>)

Worldwide contact person

If you need more information or have particular problems not covered sufficiently by these Operating Instructions, get in touch with your contact person. You can find contact information for your local contact person on the Internet:

Local contact person (<http://www.automation.siemens.com/partner>)

1.4 Notes on warranty

The contents of this manual shall not become part of or modify any prior or existing agreement, commitment or legal relationship. The sales contract contains all obligations on the part of Siemens as well as the complete and solely applicable warranty conditions. Any statements regarding device versions described in the manual do not create new warranties or modify the existing warranty.

The content reflects the technical status at the time of publishing. Siemens reserves the right to make technical changes in the course of further development.

Safety notes

 CAUTION

Correct, reliable operation of the product requires proper transport, storage, positioning and assembly as well as careful operation and maintenance. Only qualified personnel should install or operate this instrument.

Note

Alterations to the product, including opening or improper modifications of the product, are not permitted.

If this requirement is not observed, the CE mark and the manufacturer's warranty will expire.

2.1 Laws and directives

General requirements

Installation of the equipment must comply with national regulations. For example EN 60079-14 for the European Community.

Instrument safety standards

The device has been tested at the factory, based on the safety requirements. In order to maintain this condition over the expected life of the device the requirements described in these Operating Instructions must be observed.

CAUTION

Material compatibility

Siemens Flow Instruments can provide assistance with the selection of wetted sensor parts. However, the full responsibility for the selection rests with the customer and Siemens Flow Instruments can take no responsibility for any failure due to material incompatibility.

CE marked equipment

The CE-mark symbolizes the compliance of the device with the following guidelines:

- EMC-directive 2004/108/EC
- Low voltage directive 2006/95/EC

2.2 Installation in hazardous area

- Pressure equipment directive (PED/DGRL) 93/23/EC
- ATEX Directive 94/9/EC

2.2 Installation in hazardous area

 WARNING
<p>Equipment used in hazardous areas must be Ex-approved and marked accordingly. It is required that the special conditions for safe use provided in the manual and in the Ex certificate are followed!</p>

Hazardous area approvals

The device is approved for use in hazardous area and has the following approval:

- II 1G Ex ia IIC T3-T6

 WARNING
<p>Make sure the hazardous area approval is suitable for the environment in which the device will be installed.</p> <ul style="list-style-type: none"> • SITRANS F C MASS 6000 Ex d is approved for use in hazardous area. • SITRANS F C MASS 6000 19" Ex (IP65) is approved for Class I Div 2 and Zone 2. • SIFLOW FC070 Ex is approved for use in Zone 2.

Table 2- 1 Driver circuit

Driver circuit (Terminal 1-2)	
U _i	16 V
I _i	0.132 A
P _i	0.75 W
L _i or L _i /R _i	0.5 mH
C _i	50 pF

Table 2- 2 Temperature sensor circuit

Temperature sensor (Terminals 3,4 & 9)	
U _i	15 V
I _i	8 mA
P _i	0.03 W
L _i	Insignificant
C _i	50 pF

Table 2- 3 Pickup circuit

Pickup circuit (Terminals 5-6 & 7-8)	
U _i	15 V
I _i	15 mA
P _i	0.056 W
L _i	0.5 mH
C _i	50 pF

 WARNING
<p>Danger of explosion</p> <p>With intrinsically safe circuits, use only certified transmitters appropriate for the sensor.</p> <p>Do not supply the transmitter from a non-conforming power supply, since the "fail-safe" type of protection will no longer be effective and the approval certification will be invalid.</p>

Temperature specifications for Ex use

Temperature class	Ambient temperature [°C]	Process media temperature [°C]
T3	-20 ... +50	-50 ... +180
T4	-20 ... +50	-50 ... +125
T5	-20 ... +50	-50 ... +90
T6	-20 ... +50	-50 ... +60

For ambient temperatures below -10°C and above +60°C use field wiring suitable for both minimum and maximum ambient temperature.

Hazardous area safety requirements

It is required that:

- Electrical connections are in accordance with national directives such as IEC/EN60079-14 (Installing Electrical Systems in Explosion Hazardous Areas).

 WARNING
<p>Laying of cables</p> <p>Cable for use in zone 1 and 2 or 21 and 22 must satisfy the requirements for having a test voltage AC 500 V applied between the conductor/ground, conductor/shield and shield/ground.</p>

2.3 Certificates

Certificates are posted on the Internet and on the documentation CD-ROM shipped with the device.

See also

Certificates on the Internet

(<http://support.automation.siemens.com/WW/view/en/10806951/134200>)

Description

Measurement of liquids and gases

SITRANS F C Coriolis mass flowmeters are designed for measurement of a variety of liquids and gases. The meters are multi-parameter devices offering accurate measurement of mass flow, volume flow, density, fraction, °Brix/°Plato, and temperature.

Main applications

The main applications of the Coriolis flowmeter can be found in all industries, such as:

- Chemical & Pharma: Detergents, bulk chemicals, pharmaceuticals, acids, alkalis
- Food & Beverage: Dairy products, beer, wine, softdrinks, °Brix/°Plato, fruit juices and pulps, bottling, CO₂ dosing, CIP/SIP-liquids
- Automotive: Fuel injection, nozzle & pump testing, filling of AC units, engine consumption, paint robots
- Oil & Gas: Filling of gas bottles, furnace control, CNG distribution, test separators
- Water & Waste Water: Dosing of chemicals for water treatment

3.1 Design

Versions

The MASS 2100 DI 1.5 is available in a standard and high temperature version. It is designed for use with the whole range of SITRANS F C transmitters, i.e. MASS 6000 IP67, MASS 6000 19", MASS 6000 Ex d, and SIFLOW FC070.

All transmitters can be applied in remote installations only. Regardless of transmitter version, the accuracy specification remains valid.



Figure 3-1 MASS 2100 DI 1.5

Description

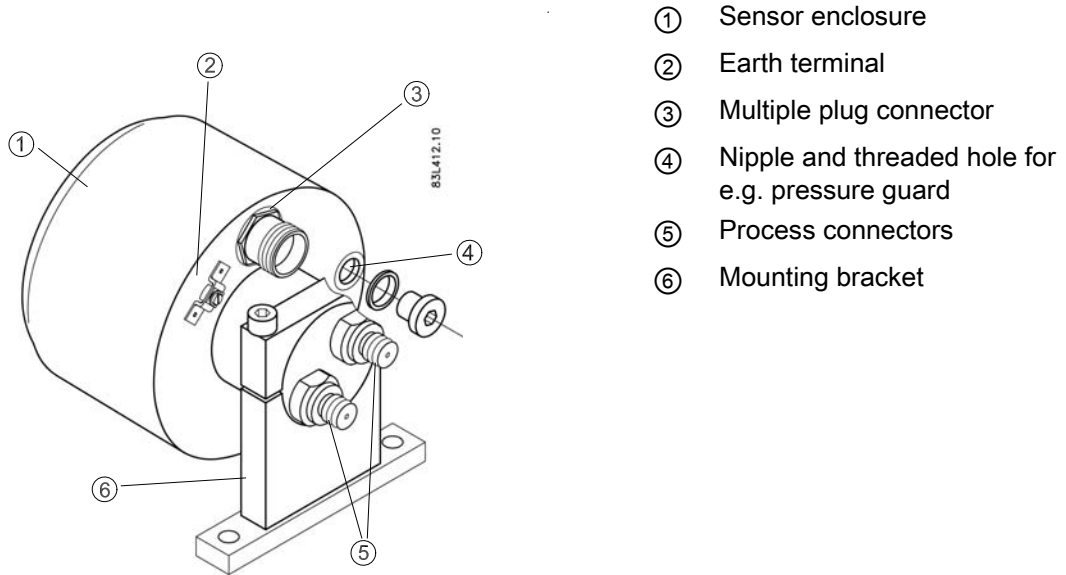

Product description

Design

The MASS 2100 sensor design is based on a single bent tube welded directly to the process connections. The tube has a large internal diameter which reduces pressure loss and improves overall flow capacity. All Mass 2100 sensors are rated intrinsically safe.

The sensors are available in two material configurations (stainless steel, AISI 316L / W1.4435, or Hastelloy C22, UNS N06022 / W2.4602). The enclosure is made of stainless steel, AISI 316L / W1.4404, with an encapsulation grade of IP66/NEMA 4.

Noise from vibrations in the process is reduced or negated through an internal isolation block.

The sensors can be equipped with a pressure guard / pressure relief or flushed with dry, inert protection gases such as argon at the corresponding hole at the end of the sensor.

3.2 Theory of operation

The flow measuring principle is based on the Coriolis law of motion.

Particles moving in a rotating / oscillating system will resist the imposed oscillations in a manner consistent with the mass and velocity (momentum). Oscillations produced by a Coriolis flowmeter as the process media is accelerated around bends result in phase distortions of the measuring tubes.

The SITRANS F C sensors are energized by an electromechanical driver circuit which oscillates the pipe at its resonant frequency. Two pickups, S1 and S2, are placed symmetrically on either side of the driver.

When the media flows through the sensor, Coriolis force will act on the measuring tube and cause a tube deflection which can be measured as a phase shift between pickup S1 and pickup S2.

The phase shift is proportional to the mass flowrate. The frequency and amplitude of the driver is automatically regulated to ensure a stable output from the 2 pickups in the region of 80 to 110 mV. The temperature of the sensor tubes is measured by a Pt1000, in order to enable accurate compensation for changes in the material stiffness. As a result the process media temperature is also accurately measured.

The flow proportional phase signal from the pickups, the temperature measurement and the driver frequency enable calculation and reporting of mass, density, volume, and temperature.

SENSORPROM

All SITRANS F C Coriolis flow meters feature a SENSORPROM memory unit which stores sensor-specific calibration data and transmitter settings for the lifetime of the product. The factory settings matching the sensor are stored in the SENSORPROM. At commissioning the flow meter commences a typical flow measurement without any initial programming. Also customer-specified settings are downloaded to the SENSORPROM.

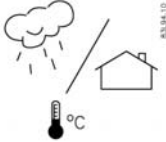

Figure 3-2 SENSORPROM memory unit

Description

3.2 Theory of operation

Installing/Mounting



SITRANS F flowmeters with minimum IP67/NEMA 4X enclosure rating are suitable for indoor and outdoor installations.

- Make sure that pressure and temperature specifications indicated on the device nameplate / label will not be exceeded.

WARNING

Installation in hazardous location

Special requirements apply to the location and interconnection of sensor and transmitter. See "Installation in hazardous area"

4.1 Installation safety precautions

WARNING

In applications with working pressures/media that can be dangerous to people, surroundings, equipment or others in case of pipe fracture, we recommend that special precautions such as special placement, shielding or installation of a pressure guard or a safety valve are taken when the sensor is mounted.

- Ensure that stresses and loading caused by e.g. earthquakes, traffic, high winds, heavy pressure pulsations, and fire damage if appropriate are taken into account during installation.
- Ensure that the flowmeter is installed such that it does not act as a focus for pipeline stresses. External loadings can cause device damage or measurement disturbance.
- Provide adequate protection to minimise any risk of contact with hot surfaces.

WARNING

Prevent personal injuries by assuring that operation in close proximity with pressure guards cannot take place.

WARNING

The sensor enclosure is not rated for pressure containment.

4.2 Determining a location

CAUTION

Do not install the sensor in the vicinity of strong electromagnetic fields, e.g. near motors, variable frequency drives, transformers etc.

Upstream / downstream

- No pipe run requirements, i.e. straight inlet/outlet sections are not necessary.
- Avoid long drop lines downstream from the sensor to prevent process media separation caused by air / vapour bubbles in the tube (min. back pressure: 0.2 Bar).
- Avoid installing the sensor immediately upstream of a free discharge in a drop line.

Location in the system

The optimum location in the system depends on the application:

- Liquid applications
Gas or vapor bubbles in the fluid may result in erroneous measurements, particularly in the density measurement.
 - Do not install the flowmeter at the highest point in the system, where bubbles will be trapped.
 - Install the flowmeter in low pipeline sections, at the bottom of a U-section in the pipeline.

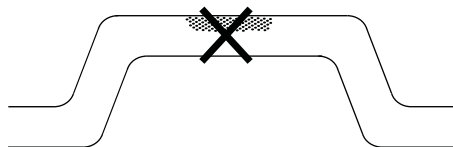

Figure 4-1 Liquid applications, wrong location with trapped air/gas

- Gas applications
Vapor condensation or oil traces in the gas may result in erroneous measurements.
 - Do not install the flowmeter at the lowest point of the system
 - Install a filter.

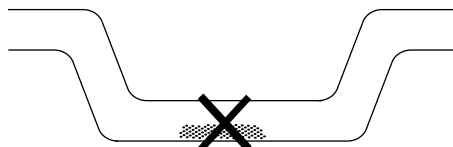

Figure 4-2 Gas applications, wrong location with trapped oil

High difference between process media temperature and ambient temperature

High temperature difference may cause 2-phase flow and result in measurement inaccuracy, especially in low flow applications.

- Insulate sensor or apply trace heating

⚠ CAUTION
Exceeded maximum operating temperature <ul style="list-style-type: none">• Make sure that the insulation / heat tracing will not cause the maximum operating temperature to be exceeded.

4.3 Orienting the sensor

Flow direction

The flow direction is indicated by the arrow on the sensor. Flow in this direction will be indicated as positive.

⚠ CAUTION
Partial drainage of the tube <p>The sensor must always be completely filled with process media in order to measure accurately.</p> <ul style="list-style-type: none">• Take appropriate measures to avoid tube drainage, e.g. by installing a valve (check/solenoid) that closes at zero flow and prevents process media from flowing back.

Orienting the sensor

MASS 2100 Di 1.5 operates in any orientation, but Siemens Flow Instruments recommends orienting the sensor according to application type:

Liquid applications

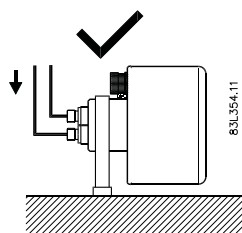

Horizontal installation, correct

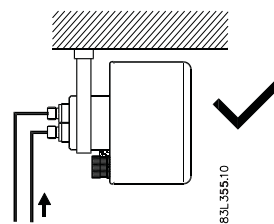

Horizontal installation, correct

4.3 Orienting the sensor

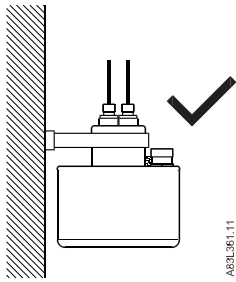

Vertical installation, correct (liquids without solid particles only)

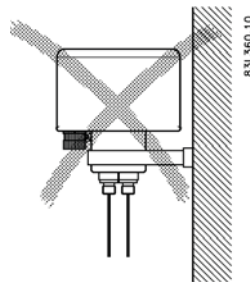

Vertical installation, wrong

NOTICE
Air / gas bubbles in the liquid
Install the flowmeter horizontally

NOTICE
Solid particles in the liquid
Install the flowmeter horizontally

Gas applications

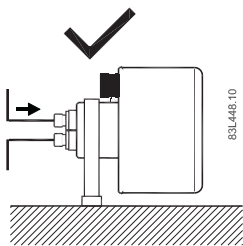

Horizontal installation 1

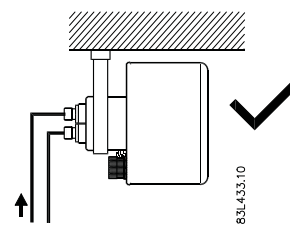

Horizontal installation 2

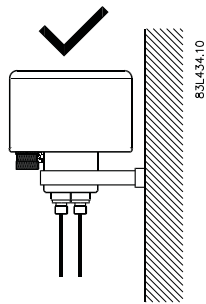

Vertical installation 1

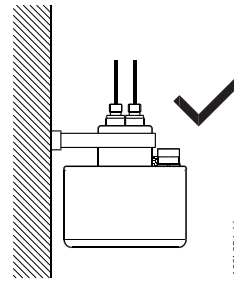

Vertical installation 2

4.4 Mounting the sensor

Installation

1. Mount the bracket to a wall or steel frame using 2 x M8 screws (not supplied)
2. Mount the sensor on the bracket using an M6 allen key

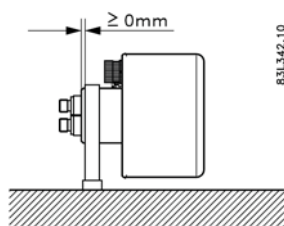
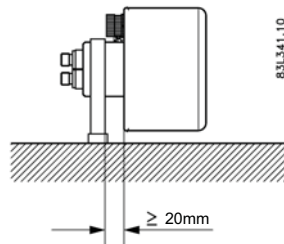

NOTICE

Ensure sufficient distance between mounting bracket and sensor in order to be able to mount the multiple plug.

Avoid vibrations

- Make sure that any valves or pumps upstream of the sensor do not cavitate and do not send vibration into the sensor.
- Decouple vibrating pipeline from the flow sensor using flexible tube or couplings

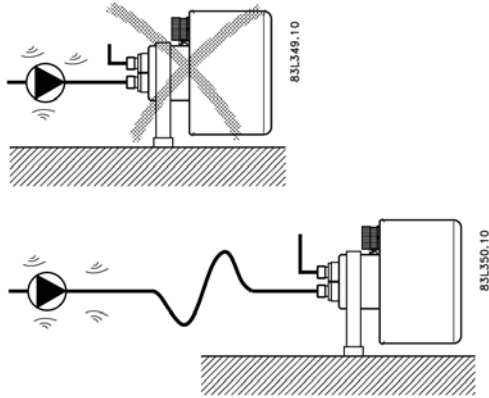

Avoid cross talk

If operating more than one flowmeter in one or multiple interconnected pipelines there is a risk of cross talk.

Prevent cross talk as follows:

- Mount sensors on different steelframes
- Keep distance between the sensors

or

- Decouple the pipelines

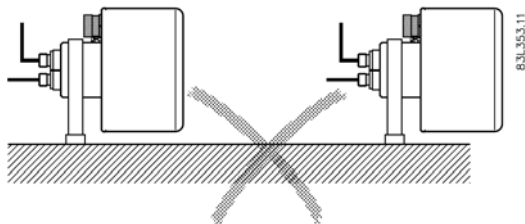

Figure 4-3 Avoid crosstalk 1

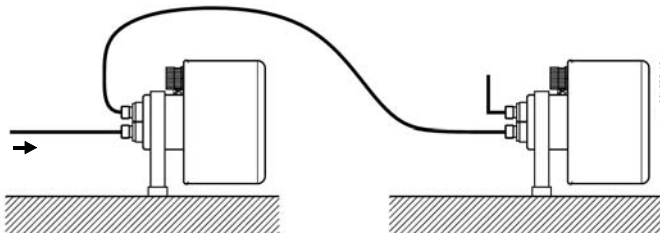

Figure 4-4 Liquid application - Avoid crosstalk 1

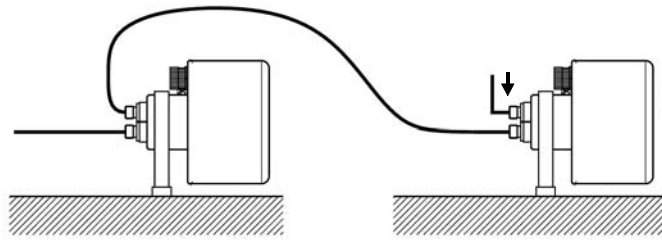
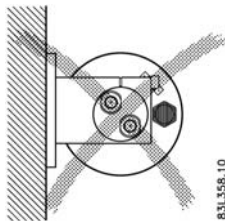
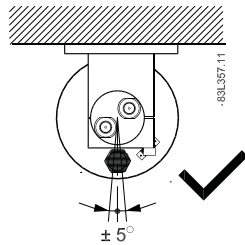
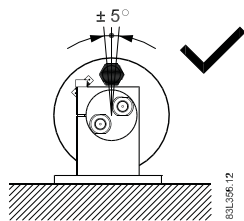

Figure 4-5 Gas application - Avoid crosstalk 2

4.5 Orienting the multiple plug connector

To obtain optimum performance in horizontal installations, orient the multiple plug connector as shown below.

The sensor can be rotated within the angles $\pm 5^\circ$.



4.6 Mounting a pressure guard

The sensor enclosure is supplied with a 1/8" plug. This plug can be used for e.g. a pressure guard, which can be connected to an automatic shut off valve which will stop the flow in case of sensor pipe fracture.

The AISI304 / EN 1.4021 exterior enclosure is rated to approximately 20 bar static pressure to contain spilt process media in the event of a tube break. However it is not intended to contain high pressure or corrosive fluids and precautions must be taken in applications where vibrating tube failure is probable and may cause damage.

Pressure guard selection

Siemens does not supply the components of the pressure guard solution because the arrangement and components are closely related to individual safety and protection practices in each place.

The selection of pressure guard solution is the responsibility of the user, however Siemens recommends the following forms of pressure guard:

- A pressure switch screwed directly or piped into one of the purge ports and connected to an automatic shutoff valve will disable pressurized supply to the meter.
- A relief valve screwed directly or piped into one of the purge ports set for minimum 2 bar gauge will carry any spilt fluid to drain.

 CAUTION
Drain flow
Ensure the drain flow is safely contained away from personnel and other plant or equipment.

Mounting of pressure guard

 CAUTION
Moisture, liquids or particles getting into the sensor enclosure
All sensors are filled with argon to avoid condensation. Ingress of moisture, liquids or particles into the sensor may influence the measurement and in worst case inhibit the measuring function.
<ul style="list-style-type: none">• Avoid moisture, liquids or particles getting into the sensor enclosure

Install a pressure guard as follows:

1. Place the sensor in a dry, clean place and leave it to acclimatize until it reaches ambient temperature, preferred 20°C (68°F).
2. Carefully disconnect the plug and mount the pressure guard.
Use the replacement soft metal sealing rings provided with each new sensor for proper sealing

 **CAUTION**

Lack of proper sealing

Soft metal sealing rings only maintain a hermetic seal within the enclosure with single use.

- Ensure that soft metal sealing rings are not reused.

3. Make sure that the pressure guard does NOT touch any of the parts inside the sensor.
4. Check that the pressure guard has been correctly mounted and thoroughly tightened.

Connecting

5

The following contains a short description of how to connect the sensor for operation with transmitters SITRANS F C MASS 6000 / SIFLOW FC070. For more information, refer to the Operating Instructions for the respective transmitters.

 WARNING
Only qualified personnel may carry out work on the electrical connections.

Before connecting

- Check that serial numbers on sensor and Sensorprom unit are identical.

 WARNING
Use in hazardous locations Before connecting check that: <ul style="list-style-type: none">• No explosion hazard exists• A hazardous area access permit has been issued• All connection leads are potential free Special requirements apply to the location and interconnection of sensor and transmitter. See "Installation in hazardous area" (Page 10)

5.1 Safety precautions

 WARNING
Mains supply from building installation Class II A switch or circuit breaker (Max. 15 A) must be installed in close proximity to the equipment and within easy reach of the operator. It must be marked as the disconnecting device for the equipment.

 WARNING
Field wiring installation Ensure that the National Installation Code of the country in which the devices are installed is met.

5.2 Wiring

1. Connect transmitter and sensor using the multiple plug connector on the blue cable supplied with the sensor.

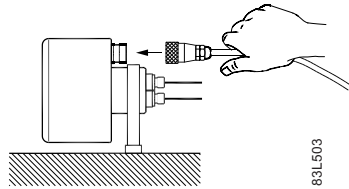

Figure 5-1 Sensor and transmitter connection

2. Connect grounding terminal ① to protective earth (PE).

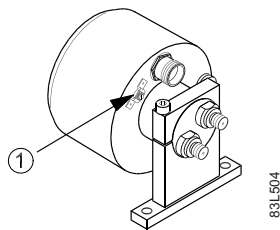

Figure 5-2 Grounding terminal

Note

Cable screen

The sensor cable screen is mechanically connected to the grounding terminal (PE), when the multiple plug is correctly tightened.

See also

Electrical connection schematics (Page 45)

Commissioning

Before commissioning it must be checked that:

- The device has been installed and connected in accordance with the guidelines provided in chapter 4 "Installing / Mounting (Page 17)" and 5 "Connecting (Page 27)"
- Device installed in hazardous location meets the requirements described in "Installation in hazardous location (Page 10)"

6.1 Zero point adjustment

The following steps describe how to set the flowmeter's zero point. Some small zero offset can be seen after a time in service. The zero point adjustment routine ensures that the flowmeter reads zero flow when flow is fully stopped.

For setting application specific parameters, refer to the Operating Instructions of the relevant transmitter.

Before zero point adjusting

- Install shut off devices in the pipeline. When possible, both upstream and downstream of the sensor. Otherwise: at the sensor outlet.

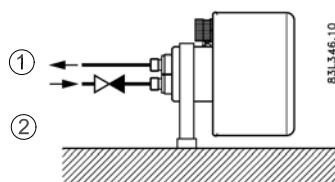

- ① Outlet
- ② Inlet

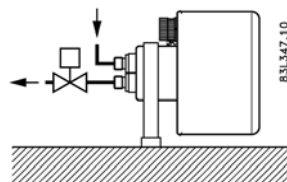

CAUTION

In order to avoid damaging the pump and interrupting the process it is recommended to install a bypass line

Auto zero point adjustment

- Acclimatize the transmitter (have it powered on for at least 30 min).
- Pump liquid at max. flow through the sensor (min. 2 min) in order to flush out any air in the liquid.
- Stop the flow while pumping by shutting off the outlet valve and then the inlet valve. Wait min. 1 minute. In this way the adjustment is made under process pressure conditions and any suspended vapors settle out of the sensor.

Note

The flow must be completely stopped and the sensor completely filled with liquid.

- Perform an auto zero point adjustment:

MASS 6000	SIFLOW FC070
Choose menu entry "Reset mode" -> Zero adjust -> Zero adjust auto	Choose the SIMATIC PDM menu -> Device -> zero adjust

For further information on performing an auto zero point adjustment, refer to the relevant transmitter Operating Instructions.

- After count down (30 s.), the actual zero point is displayed and the meter ready for operation.

Service and maintenance

7.1 Maintenance

The device is maintenance-free, however, a periodic inspection according to pertinent directives and regulations must be carried out.

An inspection can include check of:

- Ambient conditions
- Seal integrity of the process connections, cable entries, and cover screws
- Reliability of power supply, lightning protection, and grounds

7.2 Transportation and storage

To guarantee sufficient protection during transport and storage, observe the following:

- Keep the original packaging for subsequent transportation.
- Devices/replacement parts should be returned in their original packaging.
- If the original packaging is no longer available, ensure that all shipments are properly packaged to provide sufficient protection during transport. Siemens cannot assume liability for any costs associated with transportation damages.

 CAUTION
Insufficient protection during storage The packaging only provides limited protection against moisture and infiltration. <ul style="list-style-type: none"> • Provide additional packaging as necessary.

Special conditions for storage and transportation of the device are listed in Chapter "Technical data (Page 35)".

7.3 Recalibration

Siemens Flow Instruments offers to recalibrate the sensor at our works in Denmark. The following calibration types are offered as standard according to configuration (standard, density, °Brix/°Plato, fraction):

- Standard calibration (incl. matched pair)
- Customer specified calibration (incl. matched pair)
- Accredited Siemens EN45001 calibration (incl. matched pair)

- Density calibration (incl. fraction setup if requested)
- Witness calibration (incl. matched pair)

Note

For recalibration the SENSORPROM memory unit must always be returned with the sensor

7.4 Technical support

If you have any technical questions about the device described in these Operating Instructions and do not find the right answers, you can contact Customer Support:

- Via the Internet using the **Support Request**:
Support request (<http://www.siemens.com/automation/support-request>)
- Via Phone:
 - Europe: +49 (0)911 895 7222
 - America: +1 423 262 5710
 - Asia-Pacific: +86 10 6475 7575

Further information about our technical support is available on the Internet at Technical support (<http://support.automation.siemens.com/WW/view/en/16604318>)

Service & Support on the Internet

In addition to our documentation, we offer a comprehensive knowledge base online on the Internet at:

Service and support (<http://www.siemens.com/automation/service&support>)

There you will find:

- The latest product information, FAQs, downloads, tips and tricks.
- Our newsletter, providing you with the latest information about your products.
- Our bulletin board, where users and specialists share their knowledge worldwide.
- You can find your local contact partner for Industry Automation and Drives Technologies in our partner database.
- Information about field service, repairs, spare parts and lots more under "Services."

Additional Support

Please contact your local Siemens representative and offices if you have additional questions about the device

Find your contact partner at:

Local contact person (<http://www.automation.siemens.com/partner>)

7.5 Return procedures

Enclose the delivery note, the cover note for return delivery and the declaration of decontamination form on the outside of the package in a well-fastened clear document pouch.

Required forms

- **Delivery Note**
 - **Cover Note for Return Delivery** with the following information
 - Cover note (<http://support.automation.siemens.com/WW/view/en/16604370>)
 - product (ordering number)
 - number of devices or spare parts returned
 - reason for the return
 - **Declaration of Decontamination**
 - Declaration of Decontamination (http://pia.khe.siemens.com/efiles/feldg/files/Service/declaration_of_decontamination_en.pdf)
 - With this declaration you certify *that the returned products/spare parts have been carefully cleaned and are free from any residues.*
 - If the device has been operated together with toxic, caustic, flammable or water-damaging products, clean the device before return by rinsing or neutralizing. Ensure that all cavities are free from dangerous substances. Then, double-check the device to ensure the cleaning is completed.
 - We shall not service a device or spare part unless the declaration of decontamination confirms proper decontamination of the device or spare part. Shipments without a declaration of decontamination shall be cleaned professionally at your expense before further proceeding.
- You can find the forms on the Internet and on the CD delivered with the device.

Technical data

Table 8- 1 Designated use

Description	Specification
Measurement of process media	<ul style="list-style-type: none"> Fluid Group 1 (Dangerous) Aggregate state: Liquid and gaseous

Table 8- 2 Function and system design

Description	Specification
Measuring principle	Coriolis
System architecture	<ul style="list-style-type: none"> Remote configuration

8.1 Measurement range

Table 8- 3 Measuring range

Massflow [kg/h (lb/h)]	0 ... 65 (0 ... 143)
Density [g/cm ³ (lb/inch ³)]	0 ... 2.9 (0 ... 0.10)
Fraction	e.g.0 ... 100 °Brix
Temperature	
Standard [°C (°F)]	-50 ... +125 (-58 ... +257)
High-temperature version [°C (°F)]	-50 ... +180 (-58 ... +356)

8.2 Performance

Reference conditions (ISO 9104 and DIN / EN 29104)

Table 8- 4 Reference conditions

Flow conditions	Fully developed flow profile
Process media temperature [°C (°F)]	20 ±2 (68 ±3.6)
Ambient temperature [°C (°F)]	20 ±2 (68 ±3.6)
Liquid pressure [bar]	2 ±1
Density [g/cm ³]	0.997
Brix [°Brix]	40
Supply voltage [%]	Un ±1
Warming-up time [min]	30
Cable length between transmitter and sensor [m]	5

Accuracy

Table 8- 5 Measuring type errors

Sensor size	DI 1.5
Number of measuring tubes	1
Massflow	
Linearity error	[%] 0.10
Repeatability error	[%] 0.05
Max. zero point error	[kg/h] 0.001
Density	
Density error	[g/c m ³] 0.001
Repeatability error	[g/cm ³] 0.0002
Temperature error	[°C] 0.5
Brix error	[°Brix] 0.2

Additions in event of deviation from reference conditions

Current output	As pulse output ($\pm 0.1\%$ of actual flow +0.05% FSO)
Effect of ambient temperature	Display/Frequency/pulse output: <ul style="list-style-type: none"> $< \pm 0.003\%/K$ measured value Current output: <ul style="list-style-type: none"> $< \pm 0.005\%/K$ act.
Effect of supply voltage	$< 0.005\%$ of measuring value on 1% alteration from U_n

8.3 Accuracy

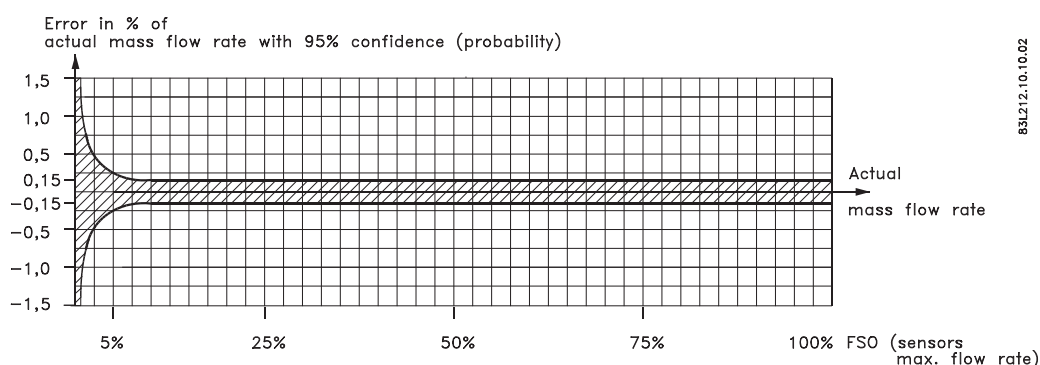

Figure 8-1 Standard calibration curve.

E current

$$E = \pm \sqrt{(0.10)^2 + \left(\frac{z \times 100}{qm}\right)^2}$$

- E = Error [%]
- Z = Zero point error [kg/h]
- qm = Mass flow [kg/h]

8.4 Rated operating conditions

Example Di1.5

- Measured mass flow $Q_m = 1.2 \text{ kg/h}$
- Max zero point error $Z = 0.001 \text{ kg/h}$

$$E = \pm \sqrt{(0.10)^2 + \left(\frac{0.001 \times 100}{1.2}\right)^2}$$

- Measuring uncertainty $E = \pm 0.13\%$

Measuring type accuracy

Version		DN 20	DN 25	DN 40	DN 50	DN 65	DN 80	DN 100	DN 150
Mass flow:	Linearity error % of rate	±0.15							
	Repeatability error % of rate	±0.1							
	Max. zero point error [kg/h]	±0.6	±0.96	±2.85	±5.52	±11.34	±14.76	±24.96	±66.00
Density error: (Standard)	[kg/l]	±0.005							
Density error (Extended)	[g/cm ³]	±0.001							N/A
Range	[g/cm ³]	0-3.5							
Repeatability error	[g/cm ³]	±0.0001							
Temperature error	[°C]	±1.0							
Brix error	[°Brix]	±0.2							N/A

N/A = Not available

8.4 Rated operating conditions

Table 8- 6 Basic conditions

Description	Specification
Ambient operating temperature (min ... max) [°C]	-20 ... +50
Ambient storage temperature [°C]	-40 ... +70
Climate class	On request
Ingress protection	IP66 / Nema 4
Relative humidity [%]	95

Table 8- 7 Process media conditions

Description	Specification
Process media temperature (T_s) (min ... max)	
Standard [°C (°F)]	-50 ... +125 (-58 ... +257)
High-temperature version [°C (°F)]	-50 ... +180 (-58 ... +356)
Process media density (min ... max) [g/cm ³ (lb/inch ³)]	0 ... 2.9 (0 ... 0.10)
Pressure of liquid in measuring tube ¹⁾	
Stainless steel [bar at °C (psi at °F)]	230 at 20 (3336 at 68)
Hastelloy C22 [bar at °C (psi at °F)]	365 at 20 (5294 at 68)
Process media viscosity	On request
Pressure drop	See chapter: "Pressure drop curves" (Page 39)
Pressure temperature ratings	See chapter "Pressure / temperature range (Page 40)

1) According to DIN 2413, DIN 17457

8.5 Pressure drop

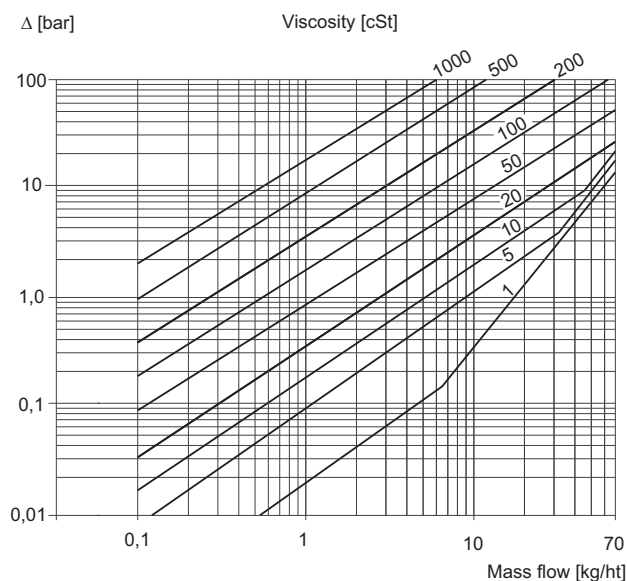

Figure 8-2 MASS 2100 DI 1.5 / 1/16", pressure drop for density = 1000 kg/m³

8.6 Pressure / temperature range

The pressure temperature ratings depend on type of process connection.

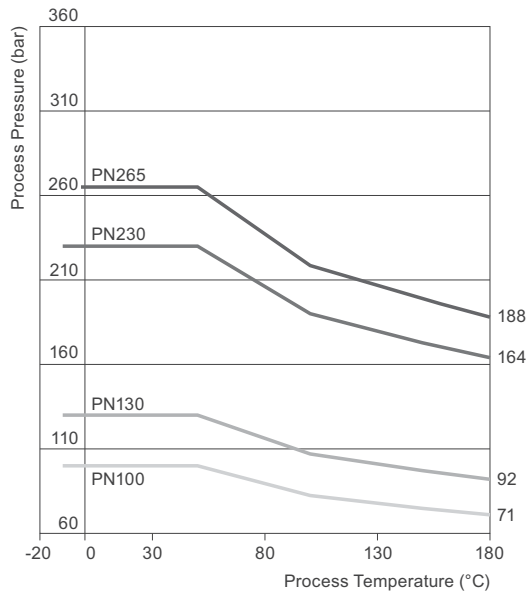

Figure 8-3 ISO 228, Pipe thread Stainless steel, AISI 316L / W.1.4435

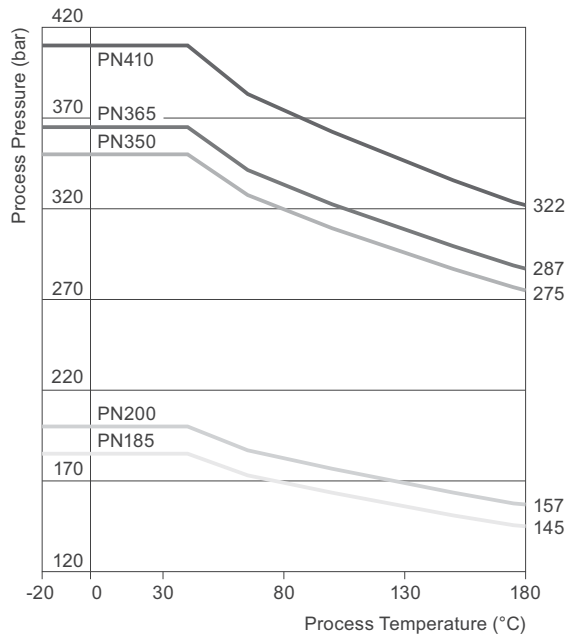

Figure 8-4 ISO 228, Pipe thread, Hasteloy C22, UNS NO6022 / W.2.4602

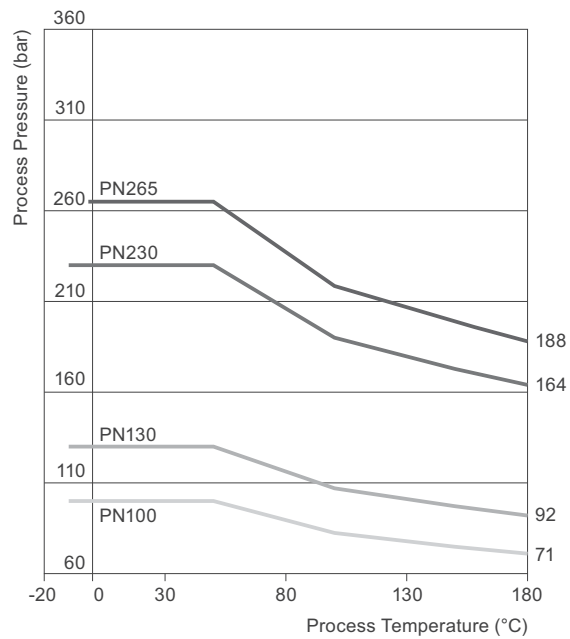

Figure 8-5 NPT ANSI/ASME B1.20.1, Pipe thread Stainless steel, AISI 316L / W.1.4435

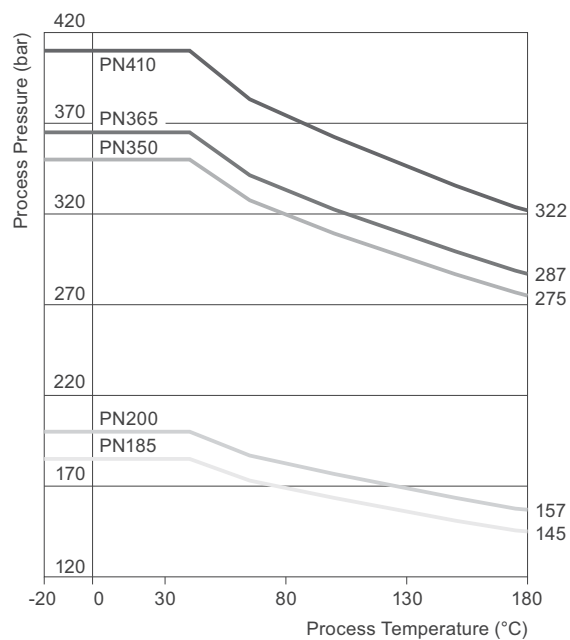

Figure 8-6 NPT ANSI/ASME B1.20.1, Pipe thread, Hastelloy C22, UNS NO6022 / W.2.4602

8.7 Design

Table 8- 8 Sensor design

Description	Specification
Dimensions	See chapter Dimensions (Page 43)
Weight (appr.) [kg (lb)]	2.6 (5.73)
Inside pipe diameter [mm (inch)] ¹⁾	1.5 (0.06)
Pipe wall thickness [mm (inch)]	0.25 (0.010)
Connection thread	
ISO 228/1	G¼" male
ANSI/ASME B1.20.1	¼" NPT male
Electrical connection	<ul style="list-style-type: none"> • Multi-pin plug • Sensor cable: 5 x 2 x 0.35 mm² twisted and screened in pairs, ext.Ø12 mm
Material	
Measuring tubes and connections	<ul style="list-style-type: none"> • Stainless steel AISI 316L / W. 1.4435 • Hastelloy C22 UNS N06022 / W. 2.4602
Sensor enclosure	Stainless steel AISI 316L / W1.4404

¹⁾ Sensor consists of one pipe

8.8 Dimensions

MASS 2100 DI 1.5 (1/16")

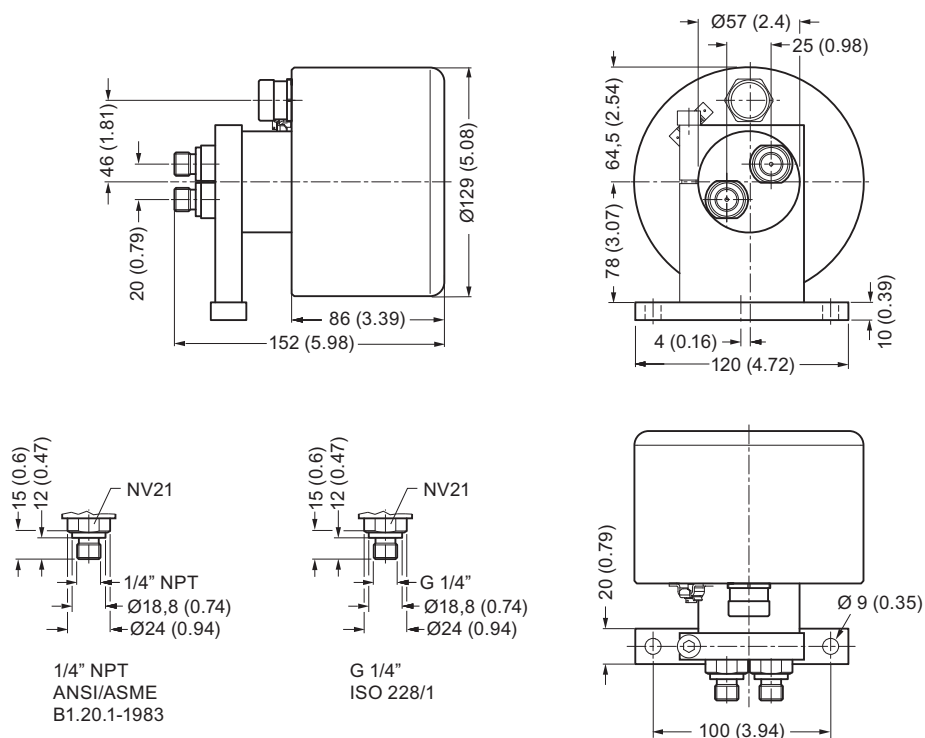

Figure 8-7 MASS 2100 DI 1.5 (1/16"), standard version, Dimensions in mm (inch)

8.9 Electrical connection schematics

Electrical connection, MASS 2100 with MASS 6000

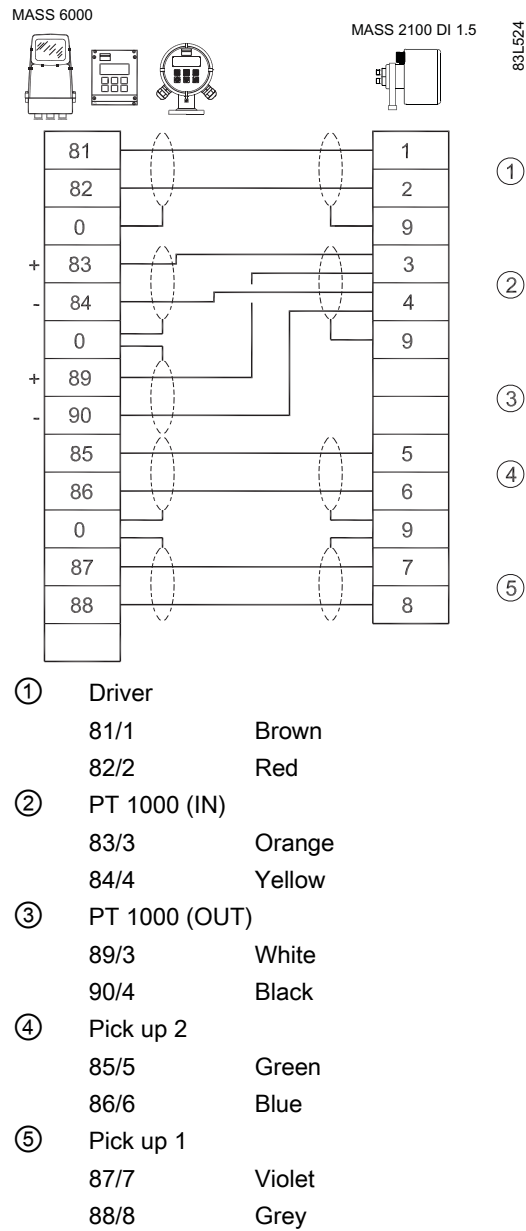

Figure 8-9 MASS 2100 / MASS 6000 Connection

8.10 Approvals and certificates

Table 8-9 Certificates and approvals

Description	Specification
CE declaration of conformity	<ul style="list-style-type: none">• EMC• LVD• PED¹⁾• ATEX
Hazardous area approval	<ul style="list-style-type: none">• II 1G Ex ia IIC T3-T6 DEMKO 03 ATEX 135252X

¹⁾ Enclosure is not rated for pressure containment

8.11 Ordering

In order to ensure that the ordering data you are using is not outdated, the latest ordering data is always available on the Internet: Process instrumentation catalog (<http://www.siemens.com/processinstrumentation/catalogs>)

Glossary

ASIC

Application-Specific Integrated Circuit is an integrated circuit (IC) customized for a particular use, rather than intended for general-purpose use.

BRIX

Degrees Brix (symbol °Bx) is a measurement of the mass ratio of dissolved sugar to water in a liquid. A 25 °Bx solution is 25% (w/w), with 25 grams of sugar per 100 grams of solution.

CAN

Controller Area Network. CAN is the leading serial bus system for embedded control. CAN is a mainstream network and was internationally standardized (ISO 11898–1) in 1993.

Coriolis

The Coriolis effect is an apparent deflection of moving objects from a straight path when they are viewed from a rotating frame of reference. The effect is named after Gaspard-Gustave Coriolis, a French scientist who described it in 1835. The Coriolis effect is caused by the Coriolis force, which appears in the equation of motion of an object in a rotating frame of reference.

DFT

The discrete Fourier transform (DFT) is one of the specific forms of Fourier analysis. As such, it transforms one function into another, which is called the frequency domain representation, or simply the DFT, of the original function (which is often a function in the time domain). The DFT evaluates enough frequency components to reconstruct the finite segment that was analyzed. The DFT is thus a transform for Fourier analysis of finite-domain discrete-time functions.

EMC

Electromagnetic compatibility (EMC) is the branch of electrical sciences which studies the unintentional generation, propagation and reception of electromagnetic energy with reference to the unwanted effects (Electromagnetic Interference, or EMI) that such energy may induce. The goal of EMC is the correct operation, in the same electromagnetic environment, of different equipment which use electromagnetic phenomena, and the avoidance of any interference effects.

Fraction

Fraction designates a proportional relation between an object part and the object whole. For example, the fraction $\frac{3}{4}$ represents three equal parts of a whole object, divided into four equal parts.

HART

HART Communication is a bi-directional industrial field communication protocol used to communicate between intelligent field instruments and host systems. HART is the global standard for smart process instrumentation and the majority of smart field devices installed in plants worldwide are HART-enabled. HART technology is easy to use and very reliable

IP

An IP (Ingress Protection) number is used to specify the environmental protection of enclosures around electronic equipment. These ratings are determined by specific tests. The IP number is composed of two numbers, the first referring to the protection against solid objects and the second against liquids. The higher the number, the better the protection. For example, in IP67 the first Number (6) means that the device is totally protected against dust, and the second (7) that it is protected against the effect of immersion between 15cm and 1m

MODBUS

MODBUS is a serial communications protocol intended for use with programmable logic controllers (PLCs). MODBUS allows for communication between many devices connected to the same network, for example a system that measures temperature and humidity and communicates the results to a computer. MODBUS is often used to connect a supervisory computer with a remote terminal unit (RTU) in supervisory control and data acquisition systems.

NAMUR

Normenarbeitsgemeinschaft für Meß- und Regeltechnik in der Chemischen Industrie (NAMUR). NAMUR is a group representing the interests of the chemical industry which create standards for instrumentation and electrical devices used in industrial plants.

PED

The Pressure Equipment Directive (97/23/EC) is the legislative framework on European level for equipment subject to a pressure hazard. It was adopted by the European Parliament and the European Council in May 1997 and has been obligatory throughout the European Union since May 2002.

Plato

Plato is a measure of the weight of the solids dissolved in water. It is expressed in %.

PROFIBUS

PROFIBUS (Process Field Bus) is a vendor-independent, open bus system standardized in the German DIN 19 245. It is a standard for field bus communication in automation technology and should not be confused with the PROFINET standard for industrial Ethernet. PROFIBUS-PA (Process Automation) is one of three PROFIBUS variants that are compatible with each other. PROFIBUS-DP (Decentralized Periphery)

SENSORPROM

All sensor related settings/data saved on an EPROM. SENSORPROM technology automatically configures the transmitter at start up providing calibration data, pipe size, sensor type, and output settings. The SENSORPROM automatically stores values or settings changed by users, and automatically re-programs any new transmitter without loss of accuracy.

Turndown ratio

'Turndown ratio' is a flow measurement term indicating the range a specific flow meter, or meter type, is able to measure with specific accuracy. It is also known as rangeability. If a gas flow to be measured is expected to vary between 100,000 m³ per day and 1,000,000 m³ per day, the specific application has a turndown ratio of at 10:1. Therefore the meter requires a turndown ratio of at least 10:1.

USM

USM II is a Communication Platform. The Siemens USM II concept enables fitting of add-on bus modules without loss of functionality:

1. All modules can be fitted as true "plug & play"
2. Module and transmitter are automatically configured through the SENSORPROM

Zero point adjustment

In order to measure accurately with a measuring instrument it is important that zero and gain have been calibrated. All Coriolis sensors are calibrated before they are sent out to customers. However, Coriolis sensors are very sensitive, and several factors might move the zero point, e.g installation, pressure, temperature and even very small vibrations coming from the process. All these factors are customer specific and can't be simulated at the factory. Therefore Siemens recommends to carry out a zero point adjustment before use.

Index

A

Accuracy, 38
Accuracy specifications, 36

C

Certificates and approvals, 46
Commissioning
 Zero point adjustment, (See Zero point adjustment)
Compliance, 9
Connection
 Electrical, (See Electrical connection)
Contact person, 7
Coriolis
 Applications, 13
 Measurement principle, 14
Cross talk, 22
Customer Support Hotline, 32

D

Decontamination, 33
Design, 42
Designated use, 35
Device
 Description, 14
 Design, 13
 Identification, 6
 Inspection, 5
Dimensions, 43
Document history, 6
Driver circuit, 10

E

Electrical connection, 45
 Basic requirements, 27

F

Flow direction, 19

H

Hazardous area
 Temperature specifications, 11
Hazardous area
 Approvals, 10
 Safety requirements, 11
Hotline, 32

I

Installation
 Gas, 18, 21
 Indoor/outdoor, 17
 Inlet / Outlet conditions, 18
 Liquid, 18, 20
 Location in the system, 18
 Multiple plug orientation, 23
 Pressure guard, 24
 Safety instructions, 17
 Sensor orientation, 19
 Upstream / Downstream, 18
Internet
 Contact person, 6, 32
 Flowdocumentation, 6
 Support, 32
Items supplied, 5

L

Laws and directives, 9

M

Mains supply, 27
Maintenance, 31
Material compatibility, 9
Mounting of sensor
 Mounting bracket, 21
Multiple-plug, 23

P

Performance, 36
Pickup circuit, 11

Pressure

- Pressure drop, 39
- Safety instructions, 17

Pressure / temperature ratings, 40

R

Rated operating conditions, 38

Recalibration, 31

Reference conditions, 36

Return procedures, 33

S

Safety, 9

- Instrument safety standards, 9

Safety instructions

- Installation, 17

Sensor orientation, (See Installation)

SENSORPROM, 15

Service, 32

Support, 32

System design, 35

T

Technical data, 35

Temperature sensor circuit, 10

Temperature specifications, 11

Theory of operation, 14

Type plate, 6

V

Vibrations, 22

Z

Zero point adjustment

- Auto zero point adjustment, 30
- Basic requirements, 29

For more information

www.siemens.com/flow

Siemens A/S
Flow Instruments
Nordborgvej 81
DK-6430 Nordborg

Subject to change without prior notice
Order No.: A5E03089952
Lit. No.: A5E03089952-01

© Siemens AG 03.2011



A 5 E 0 3 0 8 9 9 5 2 - 0 1

www.siemens.com/processautomation